

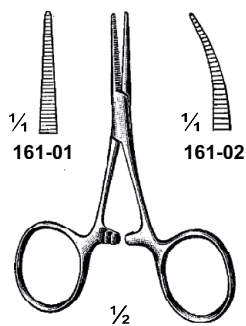

stetten
INSTRUMENTAIS CIRÚRGICOS

PINÇAS HEMOSTÁTICAS E OUTRAS

PINÇAS HEMOSTÁTICAS



Micro-Hartmann
161-01 & 161-02
9 cm / 3½"

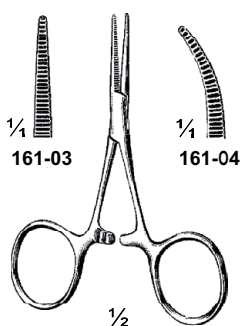

Hartmann
(Baby Mosquito)
161-03 & 161-04
9 cm / 3½"

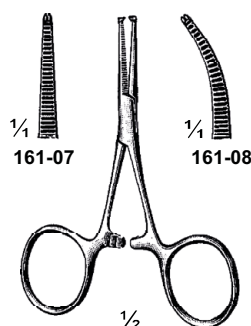

Hartmann
(Baby-Mosquito)
161-07 & 161-08
9 cm / 3½"
1 X 2 Teeth

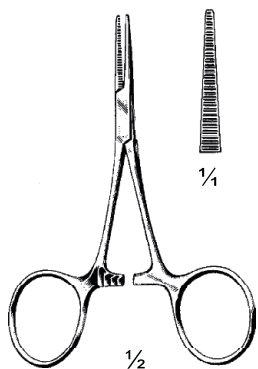

Hartmann
161-09
10 cm / 4"

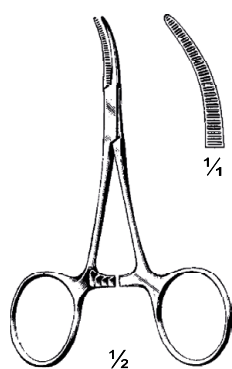

Hartmann
161-10
10 cm / 4"



Hartmann
161-11
10 cm / 4"
1 X 2 Teeth

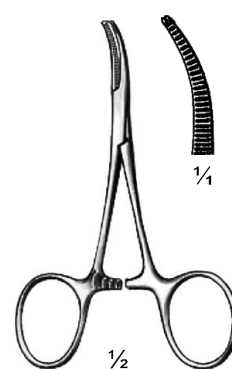

Hartmann
161-12
10 cm / 4"
1 X 2 Teeth

PINÇAS HEMOSTÁTICAS

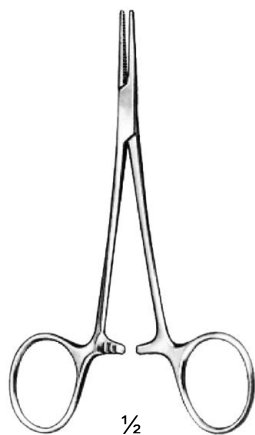

Halstead-Mosquito
162-01 To 162-08



162-01
12.5 cm / 5"



162-02
14 cm / 5 1/2"

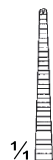

162-03
12.5 cm / 5"
1 X 2 Teeth



162-04
14 cm / 5 1/2"
1 X 2 Teeth



162-05
12.5 cm / 5"



162-06
14 cm / 5 1/2"



162-07
12.5 cm / 5"
1 X 2 Teeth



162-08
14 cm / 5 1/2"
1 X 2 Teeth



Micro-Halstead
162-10 To 162-17



162-10
10 cm / 4"



162-11
12.5 cm / 5"



162-12
10 cm / 4"
1 X 2 Teeth



162-13
12.5 cm / 5"
1 X 2 Teeth



162-14
10 cm / 4"



162-15
12.5 cm / 5"



162-16
10 cm / 4"
1 X 2 Teeth



162-17
12.5 cm / 5"
1 X 2 Teeth

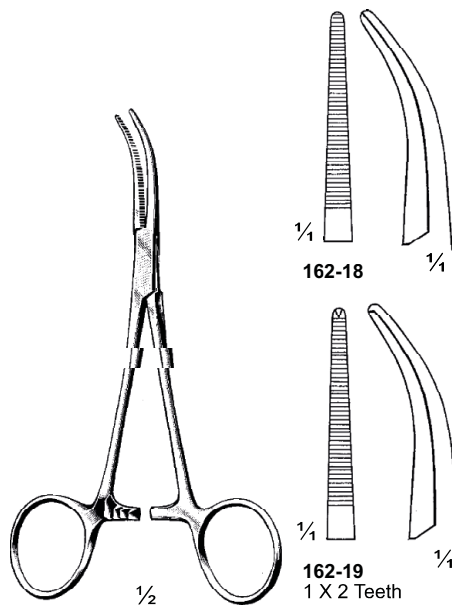

Dandy
162-18 & 162-19
14 cm / 5 1/2"



162-18



162-19
1 X 2 Teeth



PINÇAS HEMOSTÁTICAS

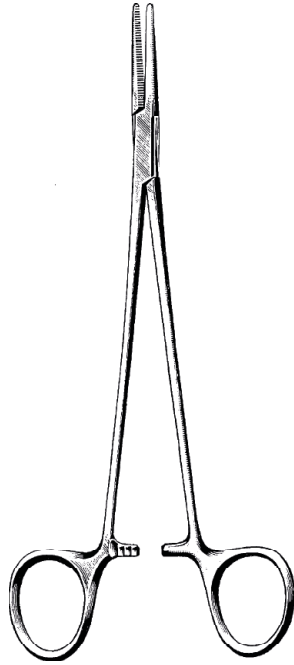

Halstead-Mosquito
163-01 To 163-08

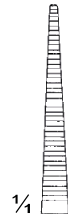

163-01
18 cm / 7"



163-02
18 cm / 7"



163-03
18 cm / 7"
1 X 2 Teeth



163-04
18 cm / 7"
1 X 2 Teeth

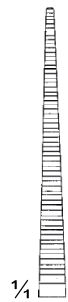

163-05
21 cm / 8¼"



163-06
21 cm / 8¼"



163-07
21 cm / 8¼"
1 X 2 Teeth



163-08
21 cm / 8¼"
1 X 2 Teeth

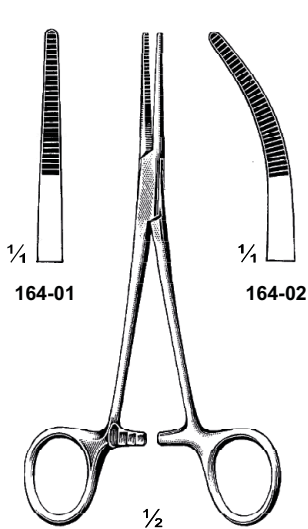

Kelly
164-01 & 164-02
14 cm / 5½"

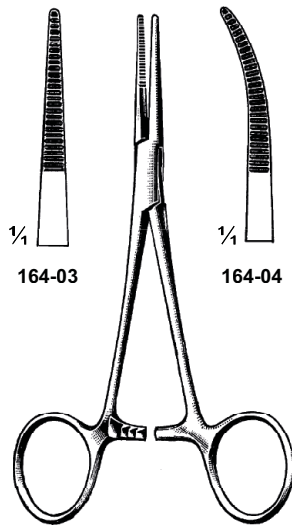

Rankin-Kelly
164-03 & 164-04
16 cm / 6¼"

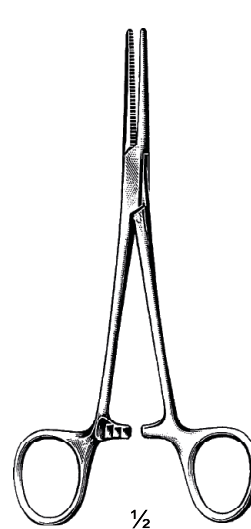

Crile
164-05 To 164-08
14 cm / 5½"



164-05



164-06



164-07
1 X 2 Teeth



164-08
1 X 2 Teeth

PINÇAS HEMOSTÁTICAS

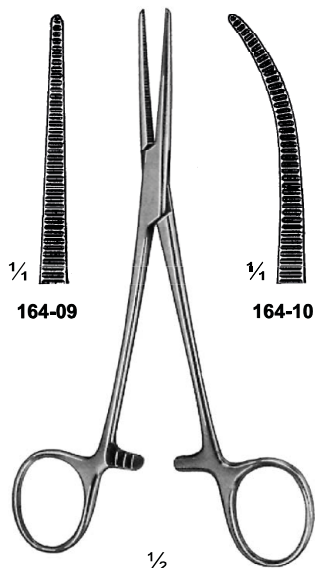

164-09

164-10

Rankin-Crile
164-09 & 164-10
16 cm / 6 1/4"

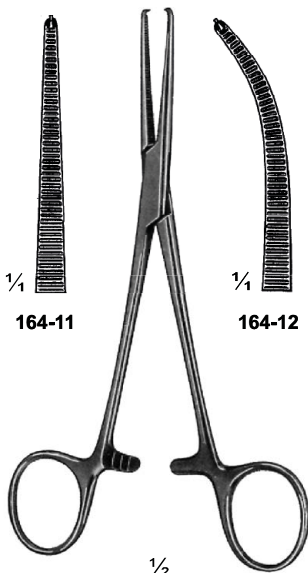

164-11

164-12

Rankin-Crile
164-11 & 164-12
16 cm / 6 1/4"
1 X 2 Teeth

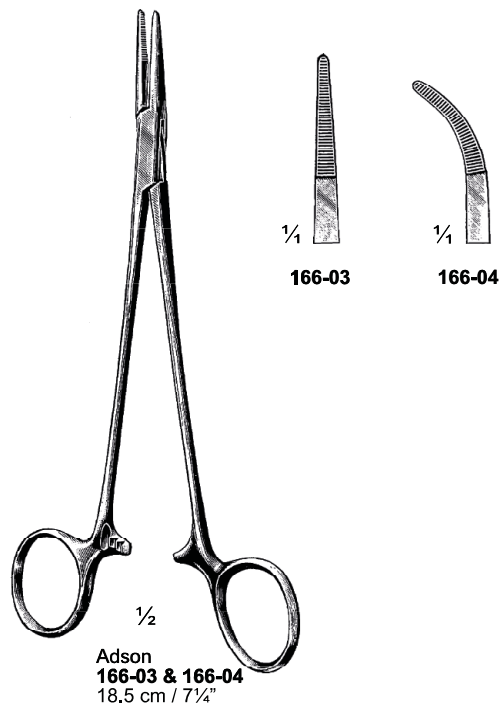

166-03

166-04

Adson
166-03 & 166-04
18.5 cm / 7 1/4"

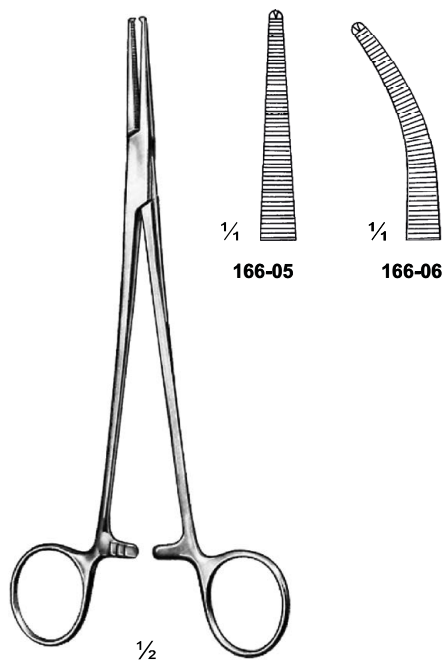

166-05

166-06

Adson
166-05 & 166-06
18.5 cm / 7 1/4"
1 X 2 Teeth

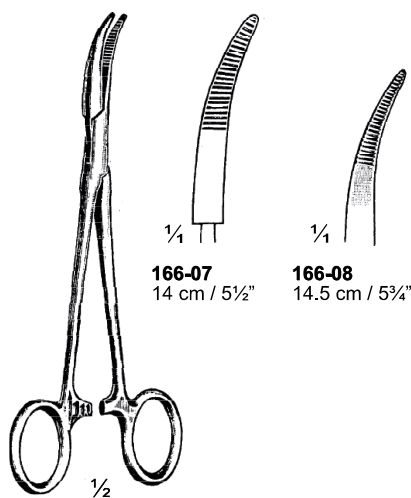

166-07

166-08

14 cm / 5 1/2"

14.5 cm / 5 3/4"

Moynihan
166-07 & 166-08

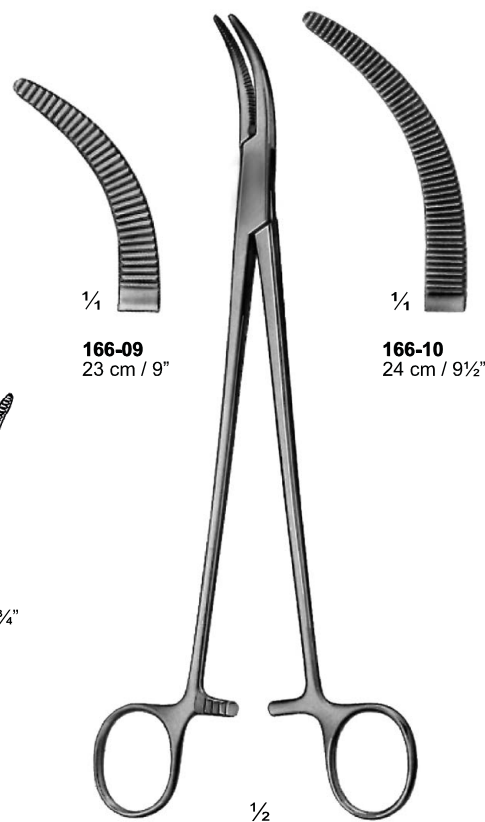

166-09

166-10

23 cm / 9"

24 cm / 9 1/2"

Moynihan
166-09 & 166-10

PINÇAS HEMOSTÁTICAS



Bengolea
167-01 To 167-12

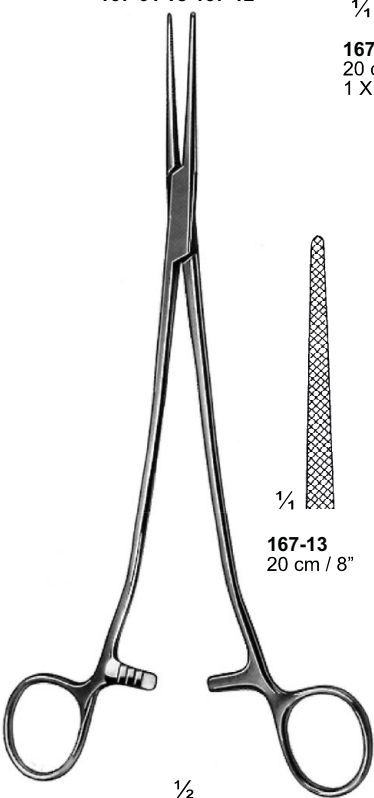
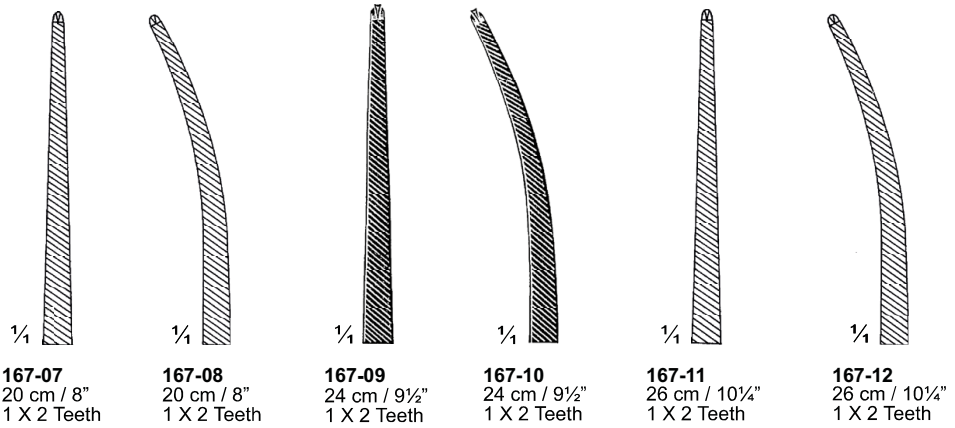
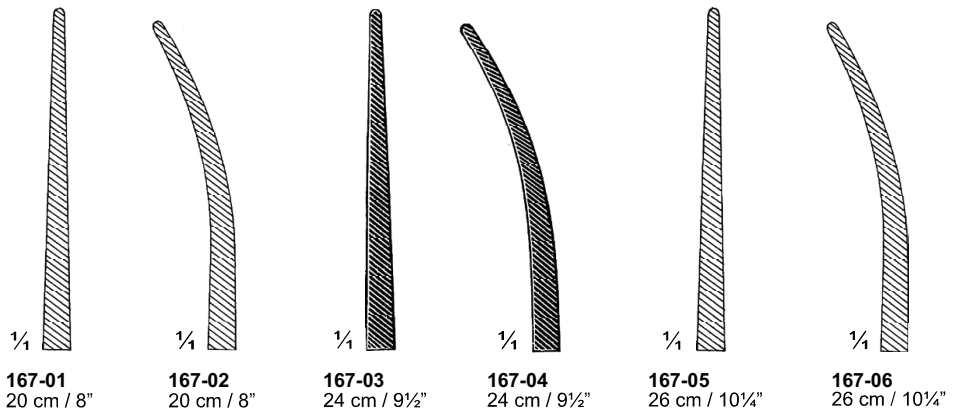

Bengolea
167-13 To 167-20

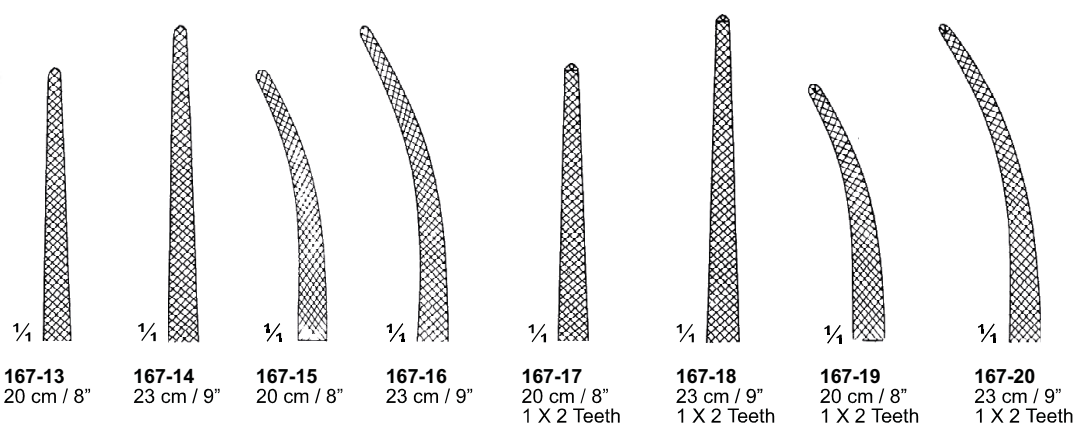

PINÇAS HEMOSTÁTICAS

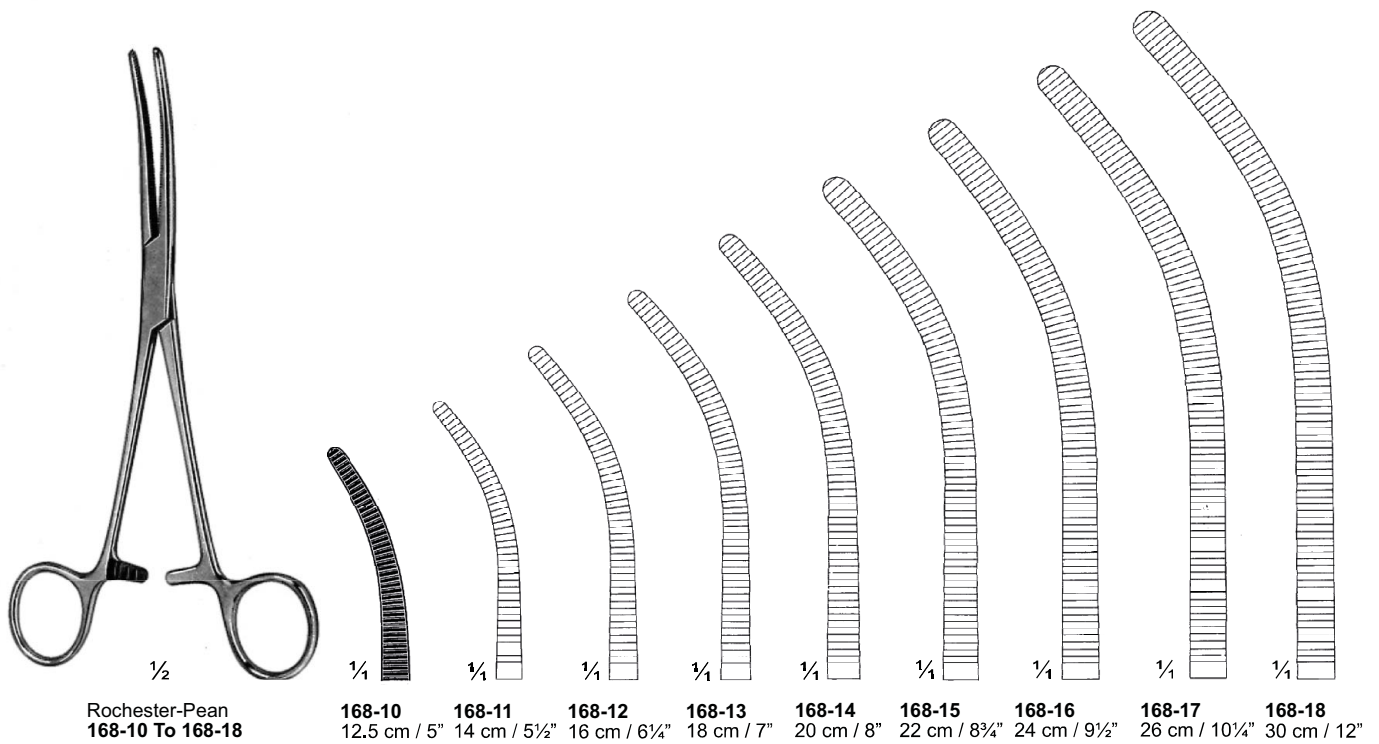
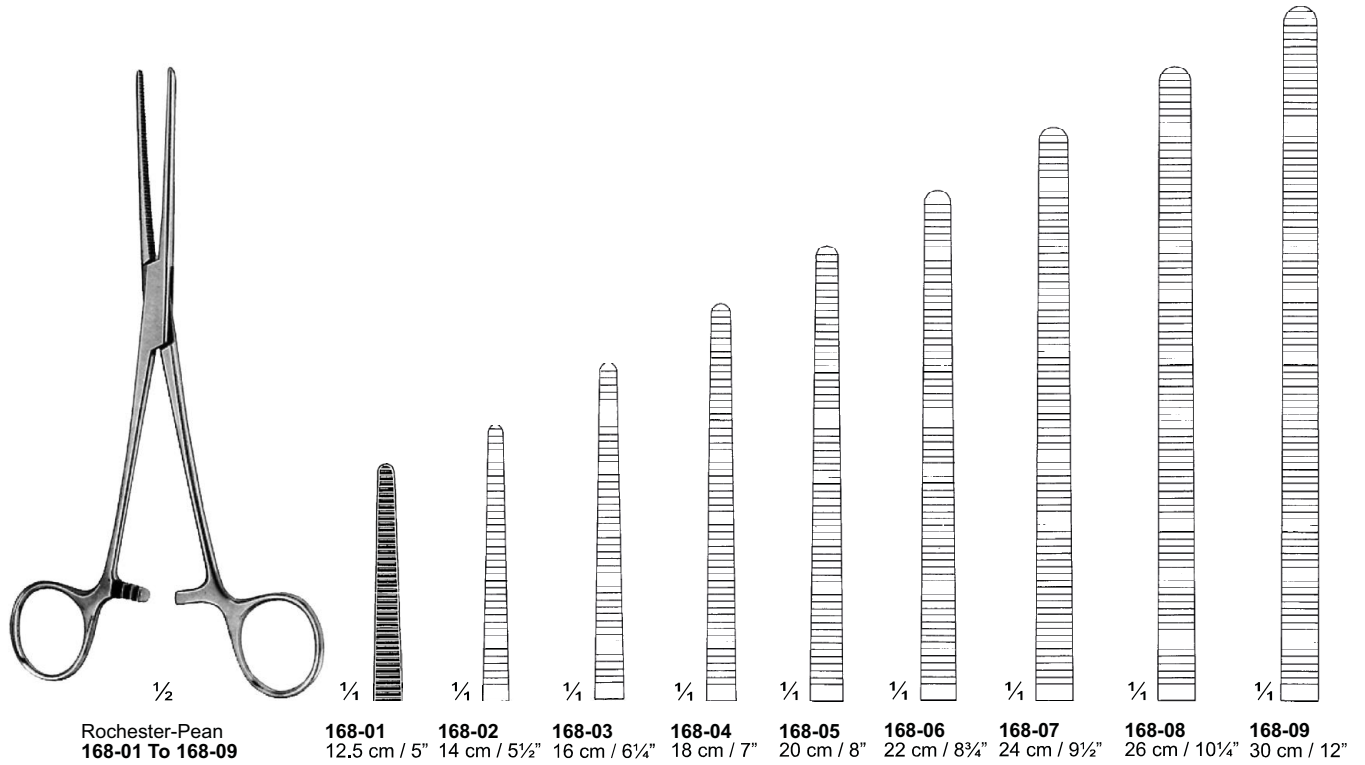

PINÇAS HEMOSTÁTICAS



Pean
169-01 To 169-06

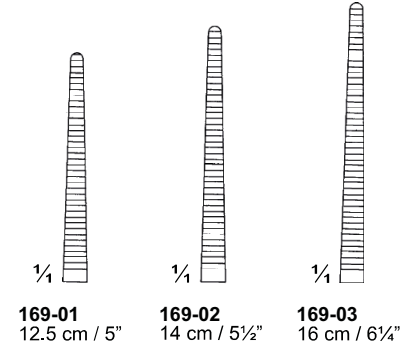

169-01 12.5 cm / 5"
169-02 14 cm / 5½"
169-03 16 cm / 6¼"

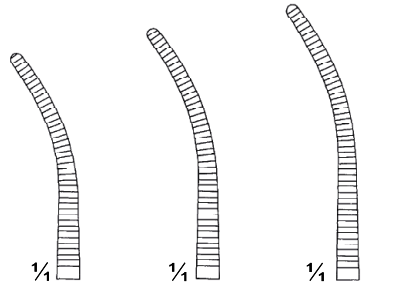

169-04 12.5 cm / 5"
169-05 14 cm / 5½"
169-06 16 cm / 6¼"

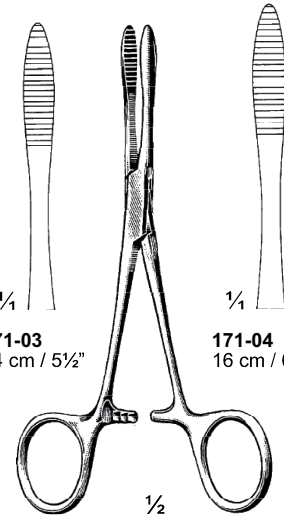

171-03 14 cm / 5½"
171-04 16 cm / 6¼"
Pean
171-03 & 171-04

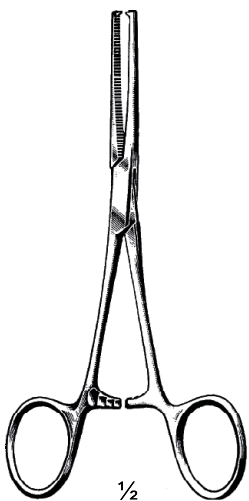

Kocher (Ochsner)
174-01 To 174-08
1 X 2 Teeth

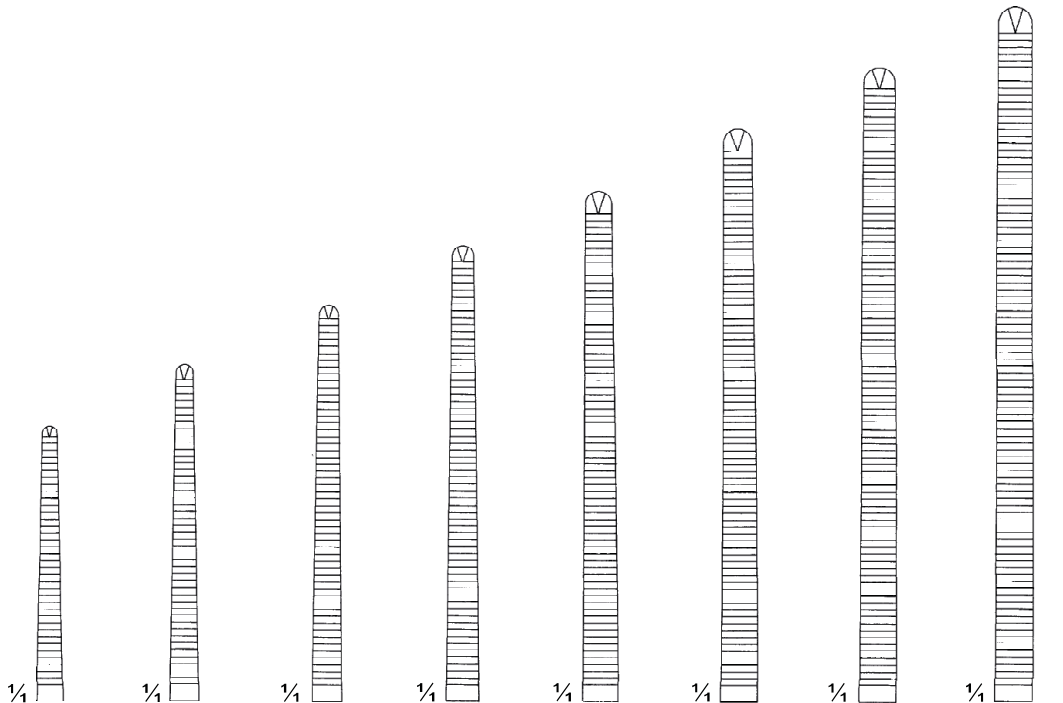

174-01 14 cm / 5½"
174-02 16 cm / 6¼"
174-03 18 cm / 7"
174-04 20 cm / 8"
174-05 22 cm / 8¾"
174-06 24 cm / 9½"
174-07 26 cm / 10¼"
174-08 30 cm / 12"

PINÇAS HEMOSTÁTICAS

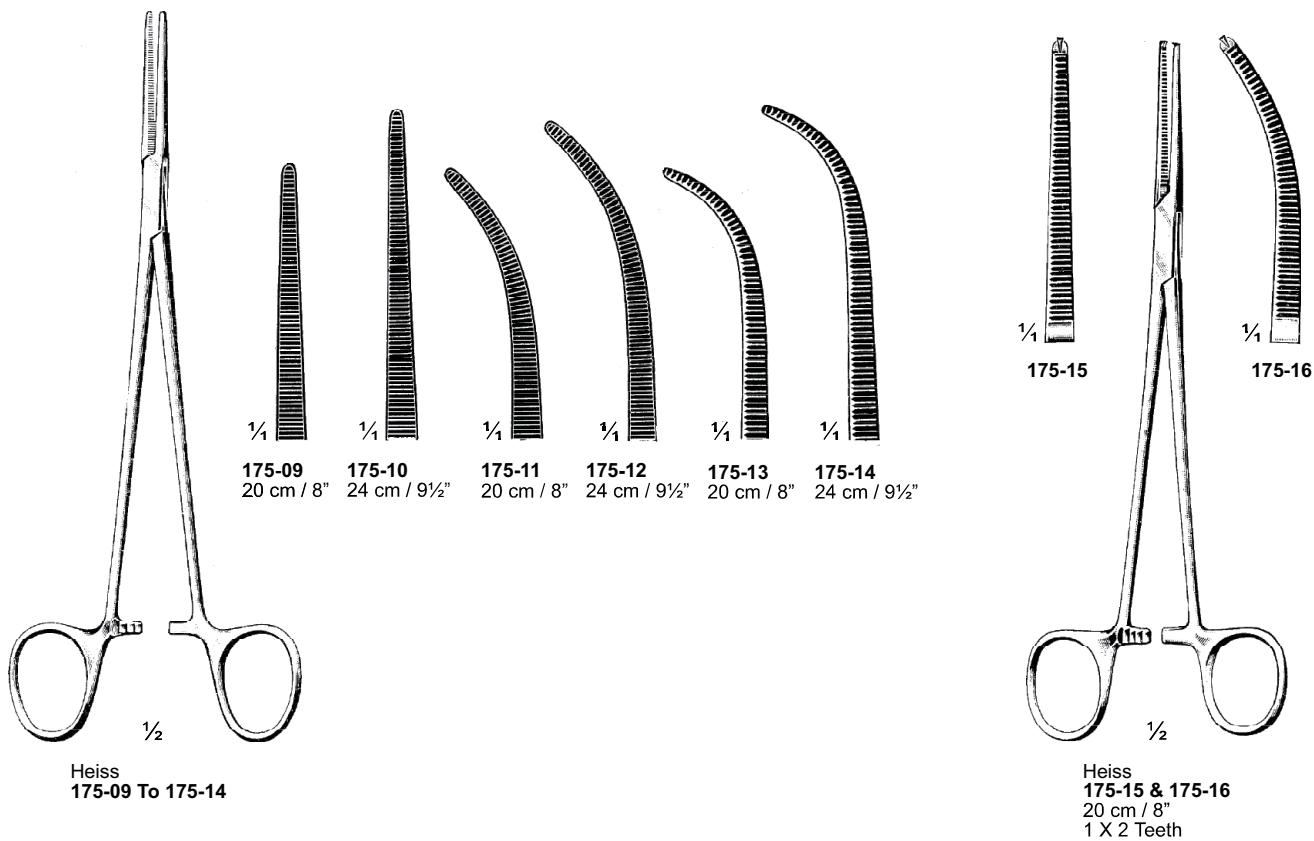
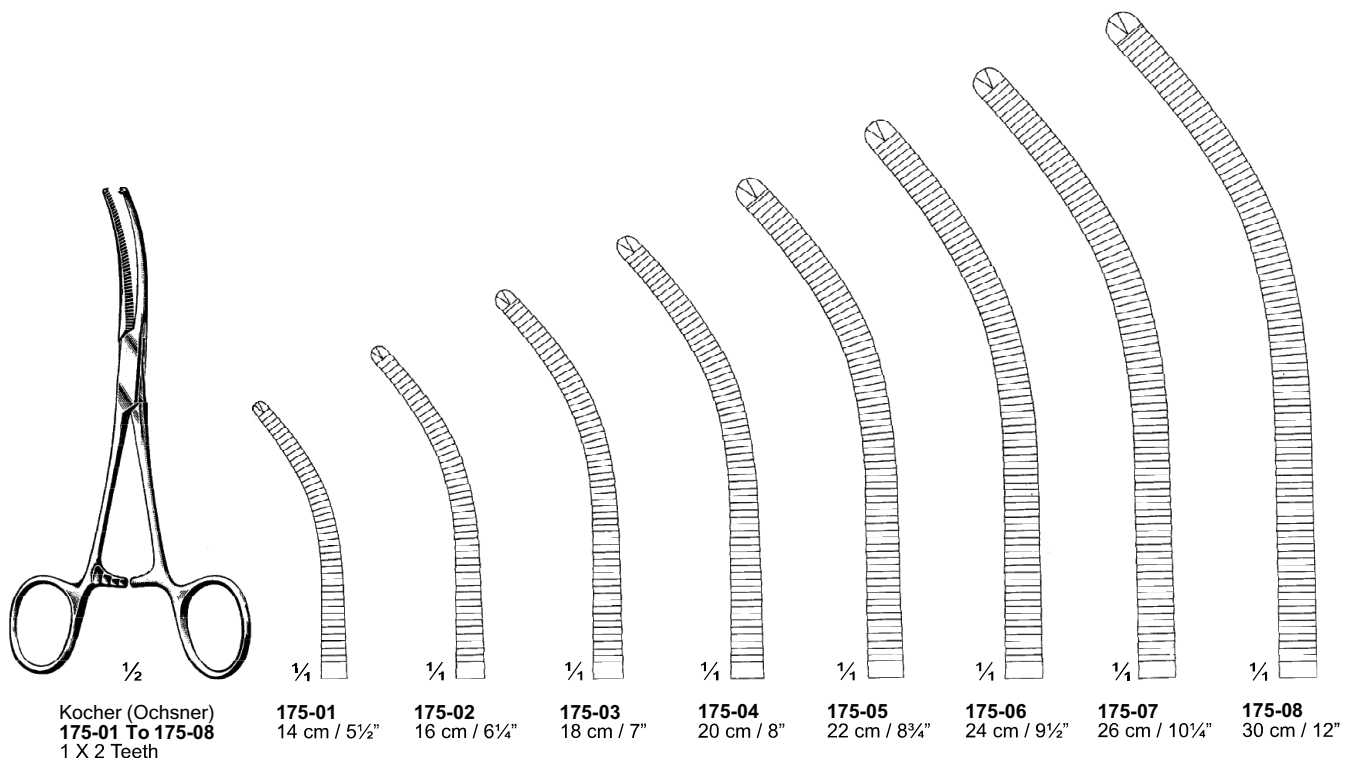

PINÇAS HEMOSTÁTICAS

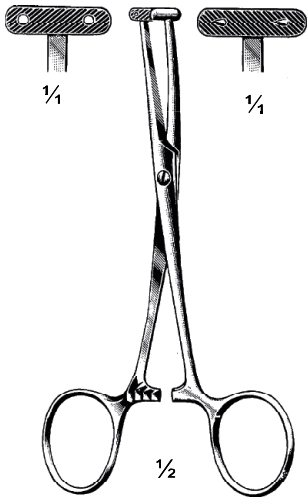

Martel
176-08
14 cm / 5½"

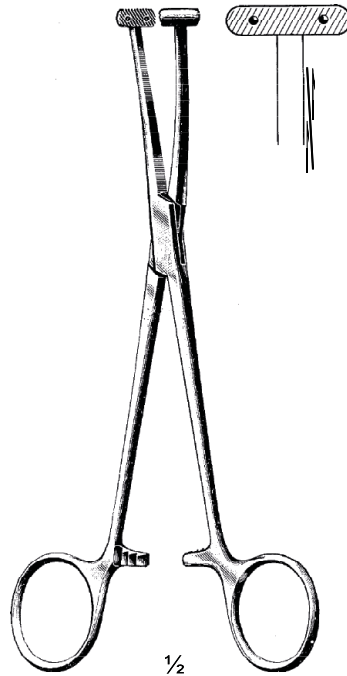

Willet-Martel
176-09
19 cm / 7½"

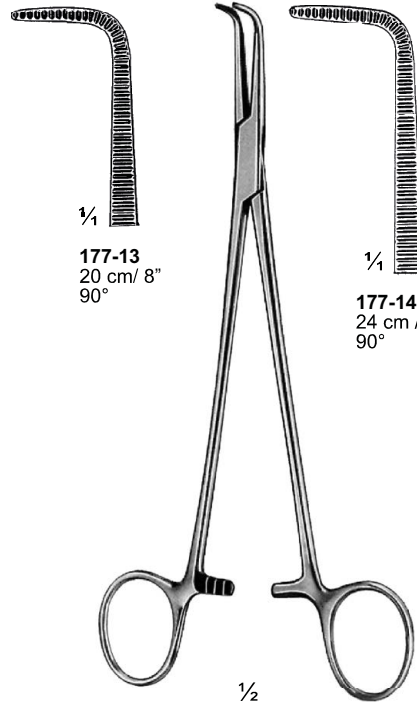

177-13
20 cm / 8"
90°

177-14
24 cm / 9½"
90°

Heiss
177-13 & 177-14



Toennis
176-10 To 176-17

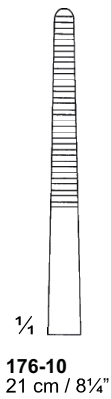

176-10
21 cm / 8¼"

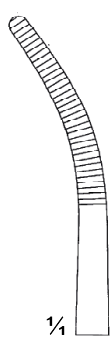

176-11
21 cm / 8¼"



176-12
26 cm / 10¼"

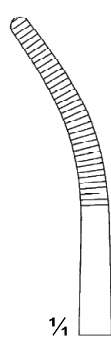

176-13
26 cm / 10¼"



176-14
21 cm / 8¼"
1 X 2 Teeth



176-15
21 cm / 8¼"
1 X 2 Teeth

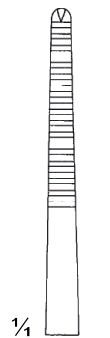

176-16
26 cm / 10¼"
1 X 2 Teeth



176-17
26 cm / 10¼"
1 X 2 Teeth

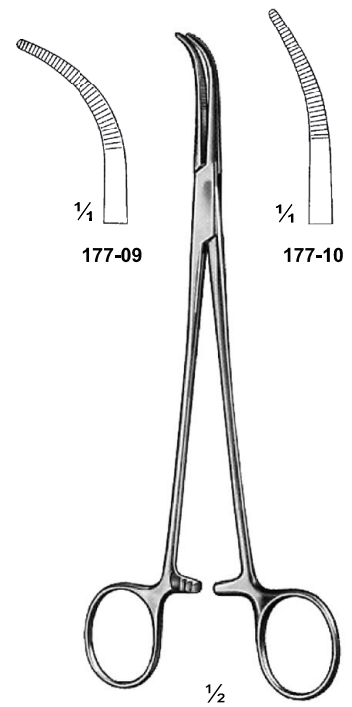

177-09

177-10

Schnidt
177-09 & 177-10
19 cm / 7½"

PINÇAS HEMOSTÁTICAS

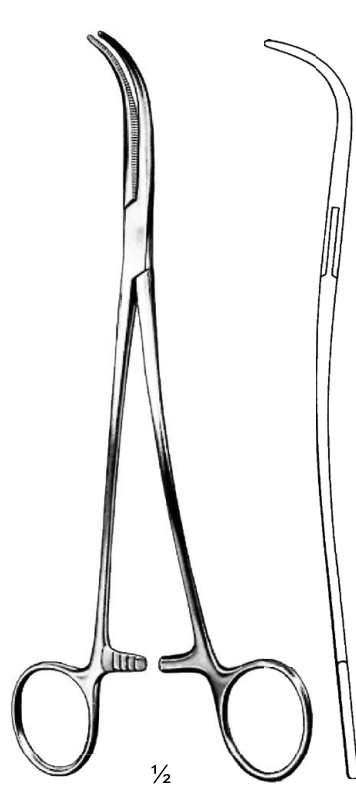

Overholt
181-01 To 181-05

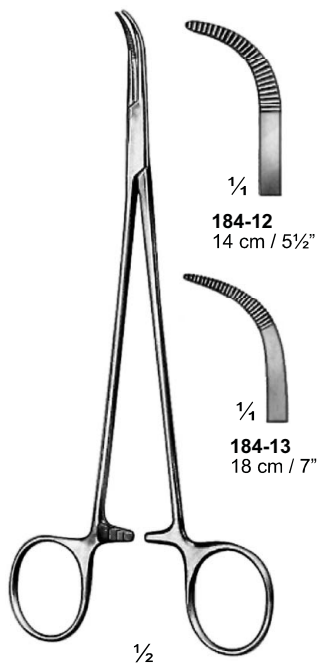
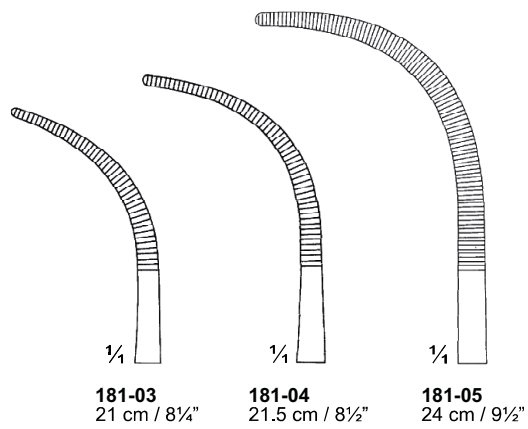
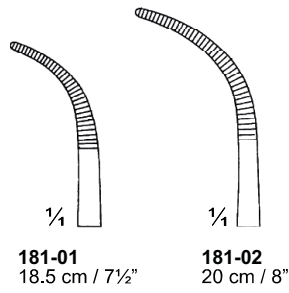

Baby-Mixer
184-12 & 184-13

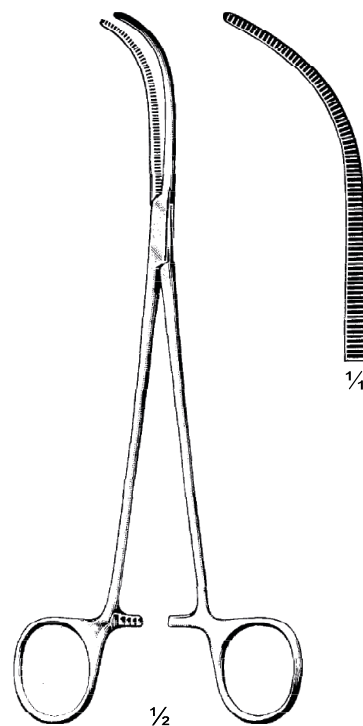

Overholt-Mixer
182-01
21 cm / 8 1/4"

PINÇAS HEMOSTÁTICAS

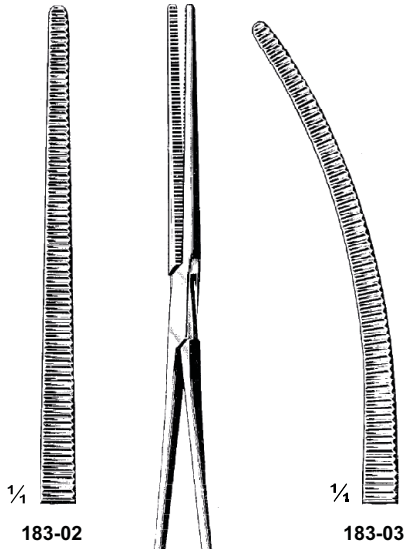

Sarot
183-02 & 183-03
24 cm / 9½"

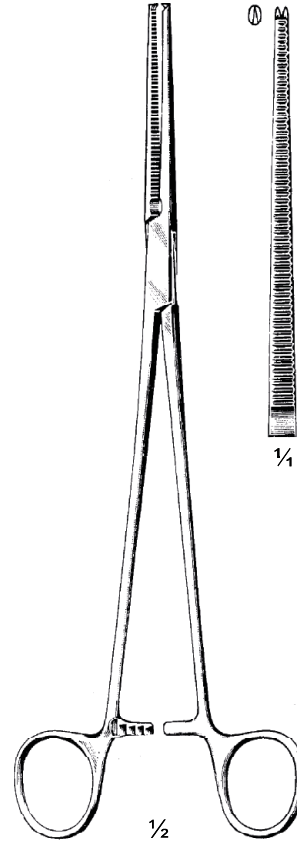

Sarot
183-04
24 cm / 9½"
1 X 2 Teeth

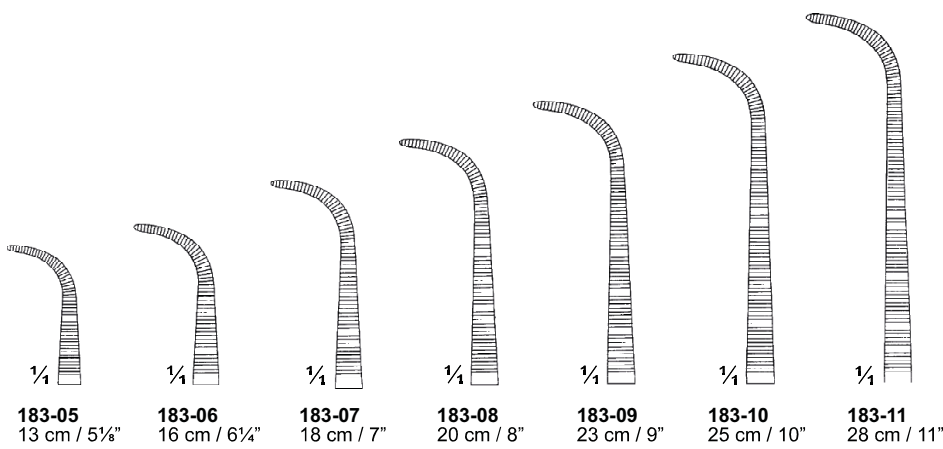

183-05
13 cm / 5½"

183-06
16 cm / 6¼"

183-07
18 cm / 7"

183-08
20 cm / 8"

183-09
23 cm / 9"

183-10
25 cm / 10"

183-11
28 cm / 11"



Gemini
183-05 To 183-11

PINÇAS HEMOSTÁTICAS

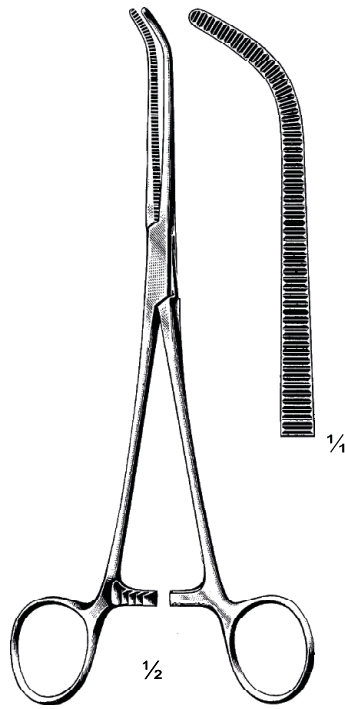

Johns-Hopkins
184-01 20 cm / 8"
184-02 23 cm / 9"
184-03 25 cm / 10"

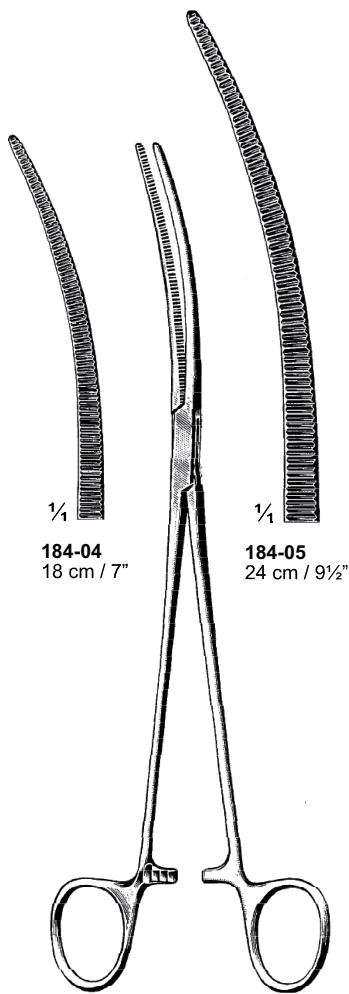

184-04
 18 cm / 7"

184-05
 24 cm / 9½"

Crafoord
184-04 & 184-05

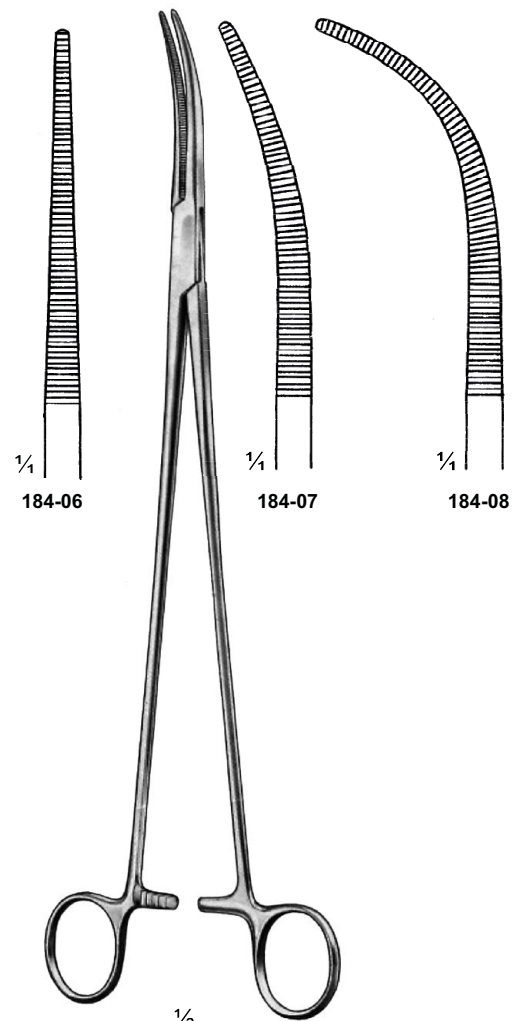

184-06

184-07

184-08

184-06 To 184-08
 29,5 cm / 11½"

PINÇAS HEMOSTÁTICAS

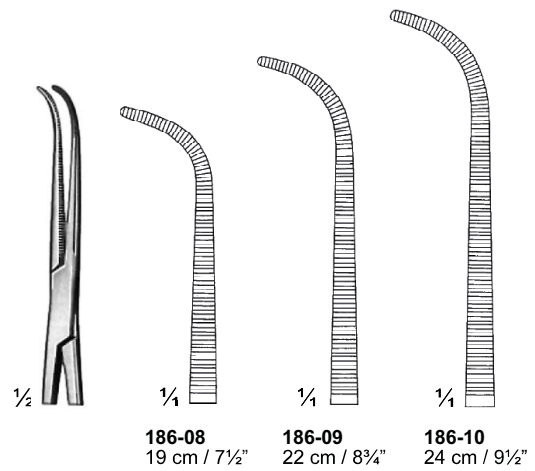
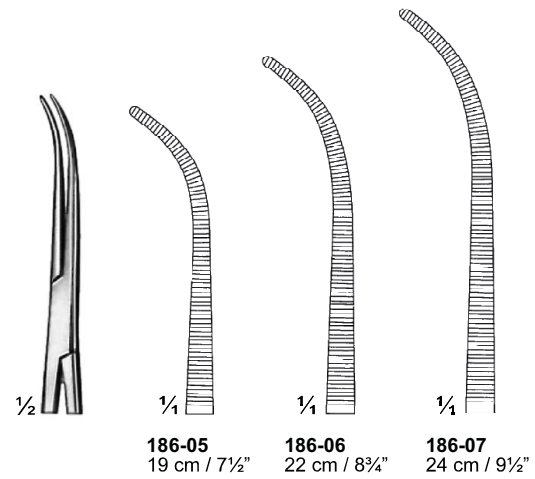
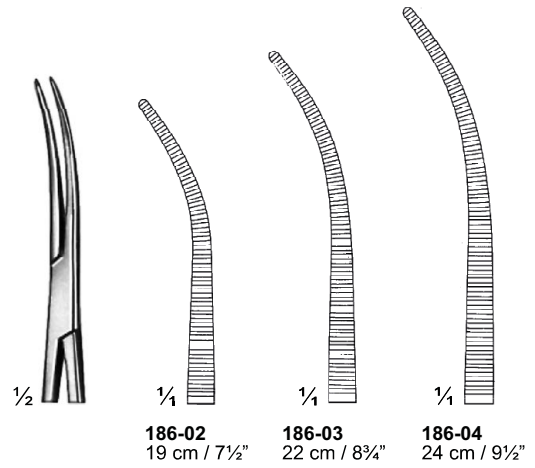
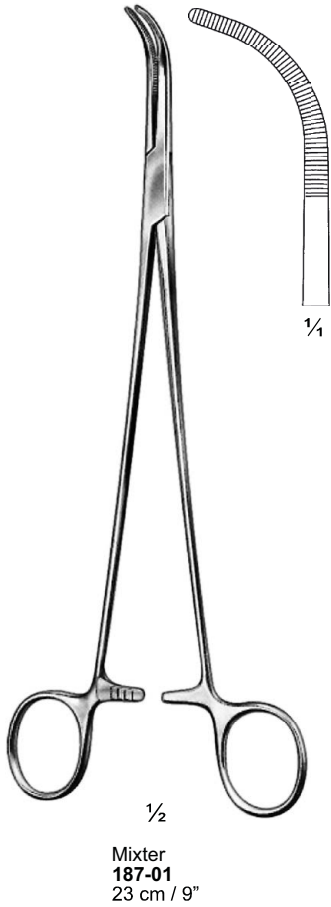

PINÇAS HEMOSTÁTICAS



Standard
209-06 To 209-08

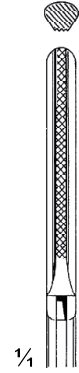

209-06
15 cm / 6"

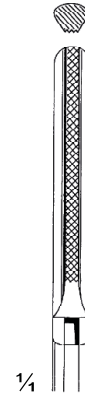

209-07
18 cm / 7"

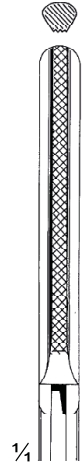

209-08
20 cm / 8"

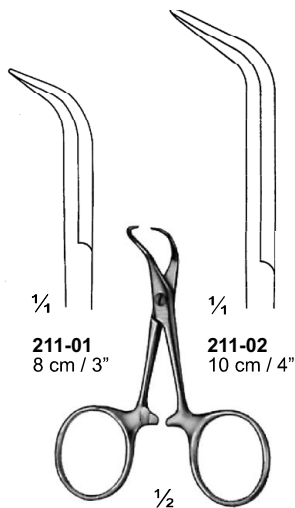

Backhaus
211-01 & 211-02

211-01
8 cm / 3"

211-02
10 cm / 4"

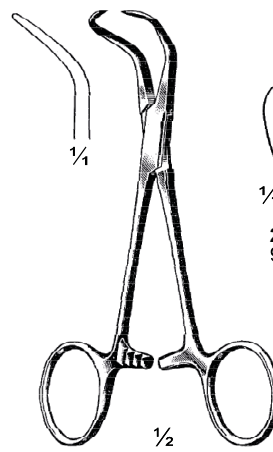

Backhaus
211-04 To 211-06



211-04
9 cm / 3½"

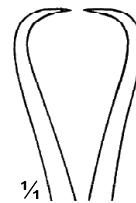

211-05
11 cm / 4¼"

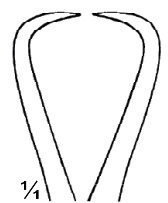

211-06
13.5 cm / 5¼"

PINÇAS HEMOSTÁTICAS

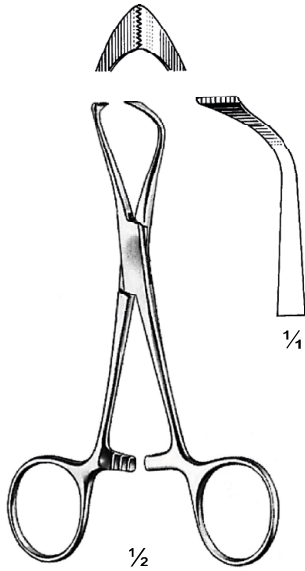

Lorna
212-02 10 cm / 4"
212-03 13 cm / 5 1/8"

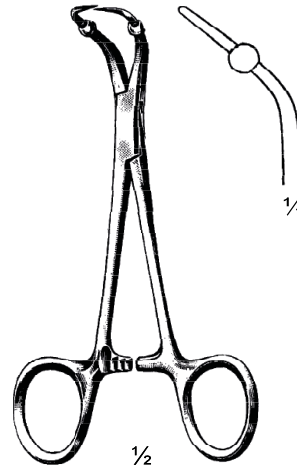

Roeder
212-09
 13.5 cm / 5 1/4"



Jones
214-02 5 cm / 2"
214-03 9 cm / 3 1/2"

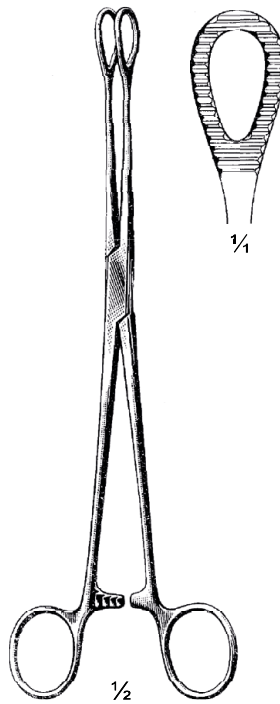

Foerster
215-01 To 215-24

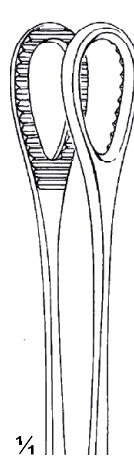

215-13 16 cm / 6 1/4"
215-14 18 cm / 7"
215-15 20 cm / 8"
215-16 23 cm / 9"
215-17 24 cm / 9 1/2"
215-18 25 cm / 10"

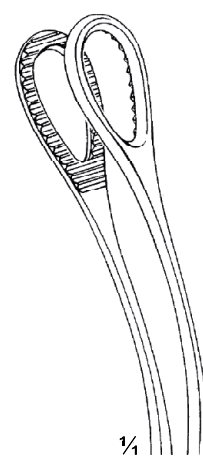

215-19 16 cm / 6 1/4"
215-20 18 cm / 7"
215-21 20 cm / 8"
215-22 23 cm / 9"
215-23 24 cm / 9 1/2"
215-24 25 cm / 10"

PINÇAS PARA BRÔNQUIO E BÍLIS

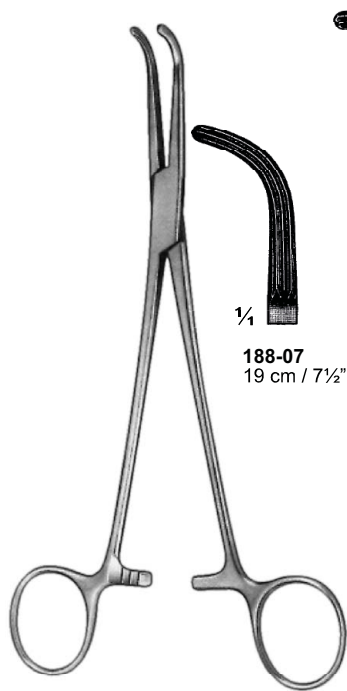

$\frac{1}{4}$
188-07
 19 cm / 7½"

$\frac{1}{4}$
188-08
 23 cm / 9"

Lahey
188-07 & 188-08

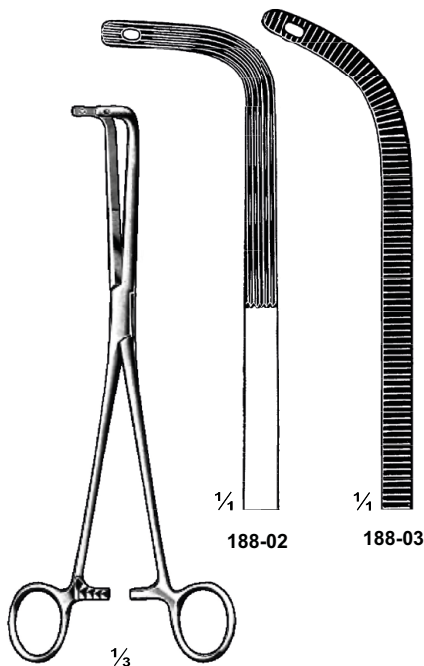

$\frac{1}{4}$
188-02

$\frac{1}{4}$
188-03

Finocchietto
188-02 & 188-03
 24 cm / 9½"

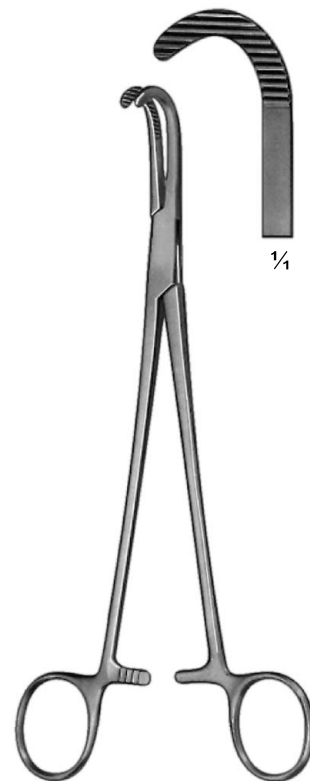

$\frac{1}{4}$

Desjardins
189-05
 22 cm / 8¾"

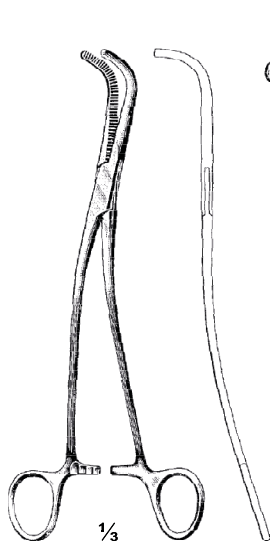

$\frac{1}{3}$

Gray
189-06 To 189-09

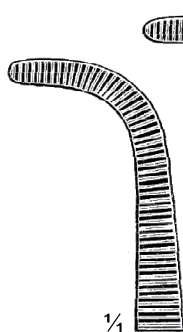

$\frac{1}{4}$
189-06
 22 cm / 8¾"

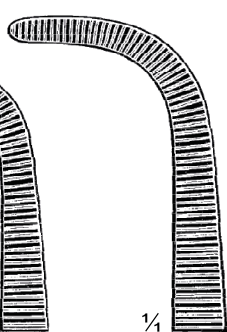

$\frac{1}{4}$
189-07
 23 cm / 9"

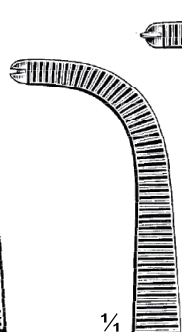

$\frac{1}{4}$
189-08
 22 cm / 8¾"
 1 X 2 Teeth

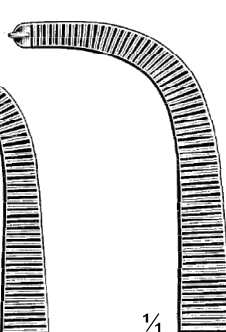

$\frac{1}{4}$
189-09
 23 cm / 9"
 1 X 2 Teeth

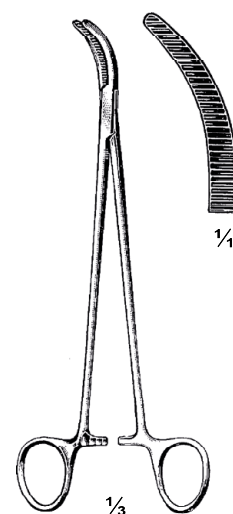

$\frac{1}{3}$

Desjardins
189-10
 21 cm / 8¼"

PINÇAS CLAMP



Guyon
190-01 To 190-04



$\frac{1}{4}$
190-01
19.5 cm / 7 $\frac{3}{4}$ "



$\frac{1}{4}$
190-02
22 cm / 8 $\frac{3}{4}$ "



$\frac{1}{4}$
190-03
23 cm / 9"



$\frac{1}{4}$
190-04
26.5 cm / 10 $\frac{1}{4}$ "



190-05
24 cm / 9 $\frac{1}{2}$ "

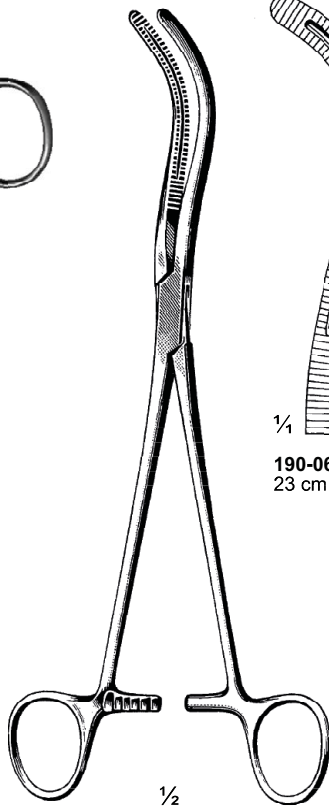

Stille
190-05 To 190-07

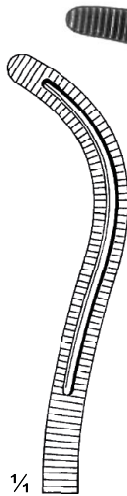

$\frac{1}{4}$
190-06
23 cm / 9"



$\frac{1}{4}$
190-07
24 cm / 9 $\frac{1}{2}$ "

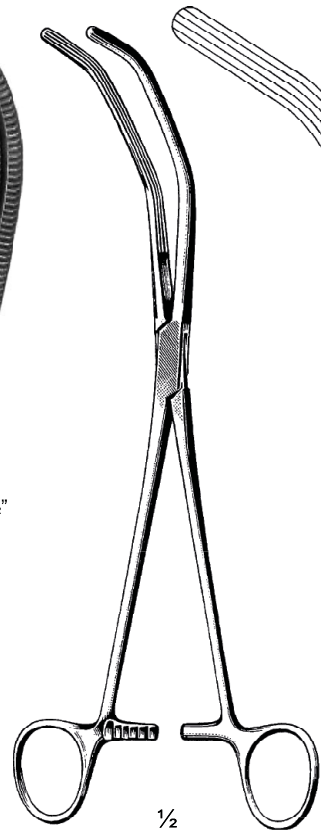

Herrick
190-08
23 cm / 9"



$\frac{1}{4}$

PINÇAS CLAMP

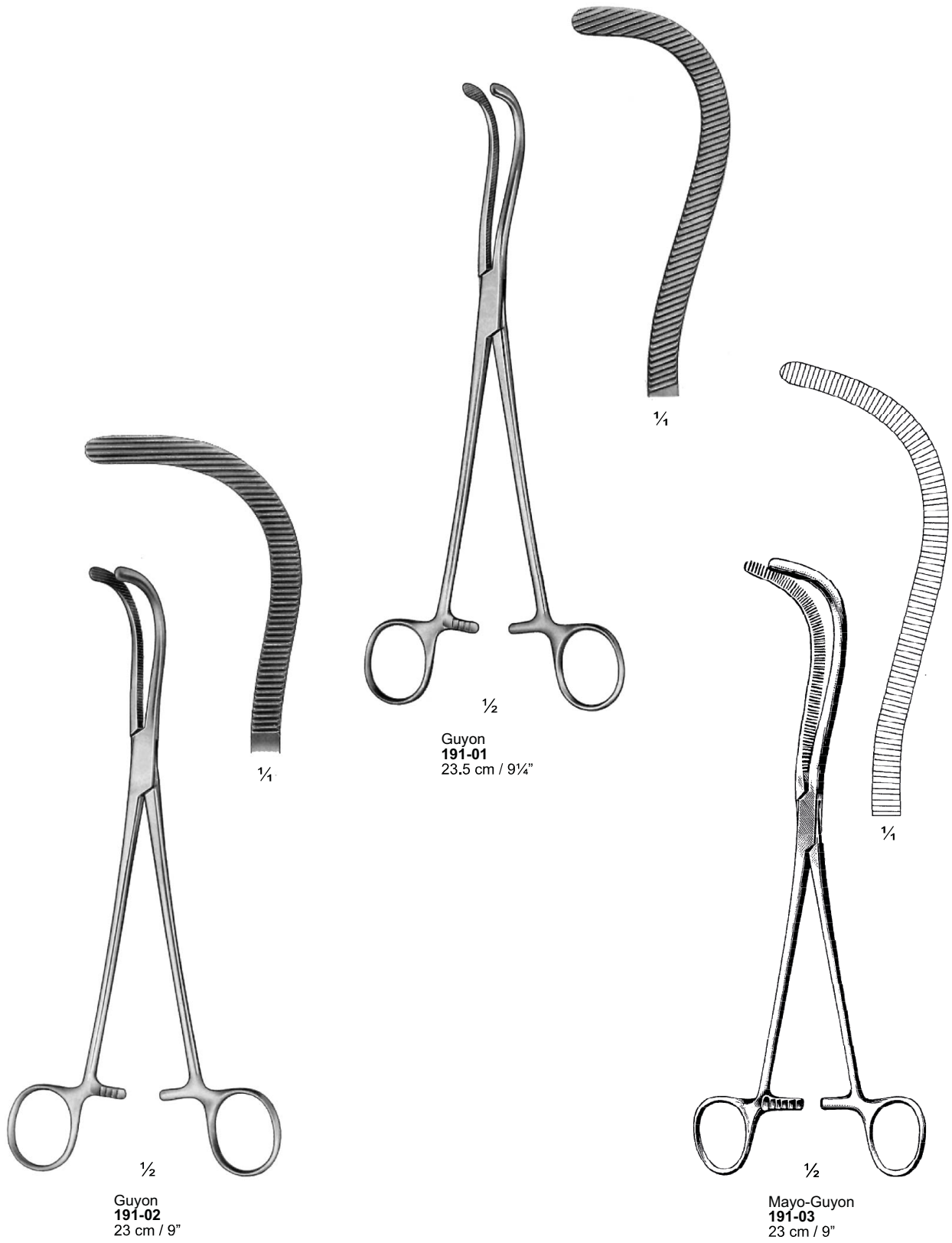

PINÇAS CLAMP

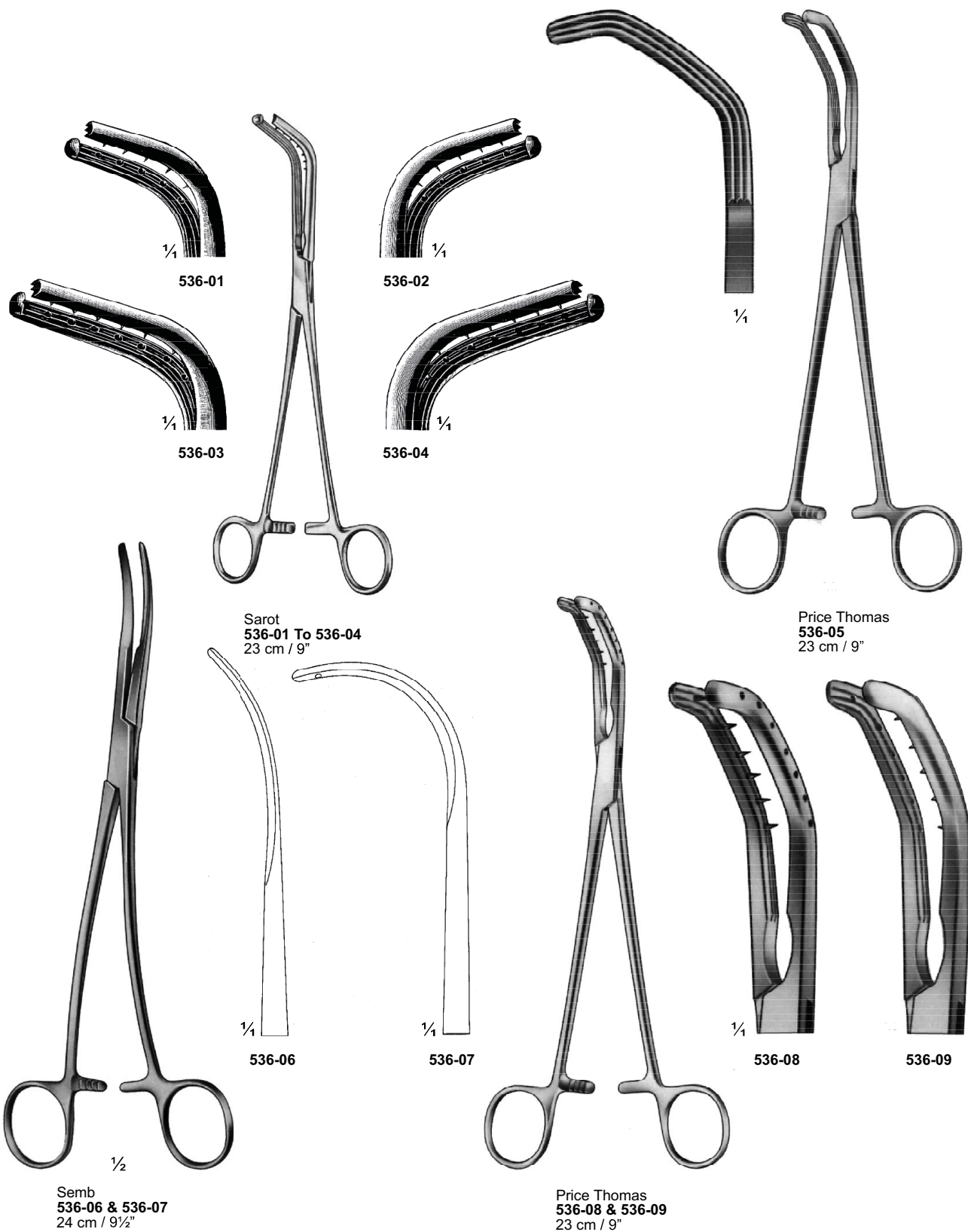

PINÇAS CLAMP

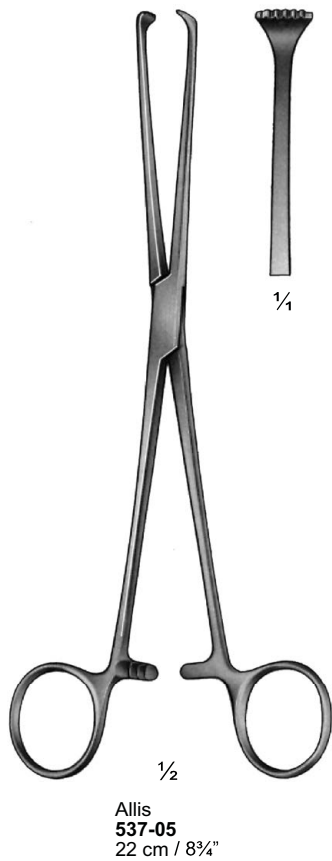

PINÇAS PARA HISTERECTOMIA

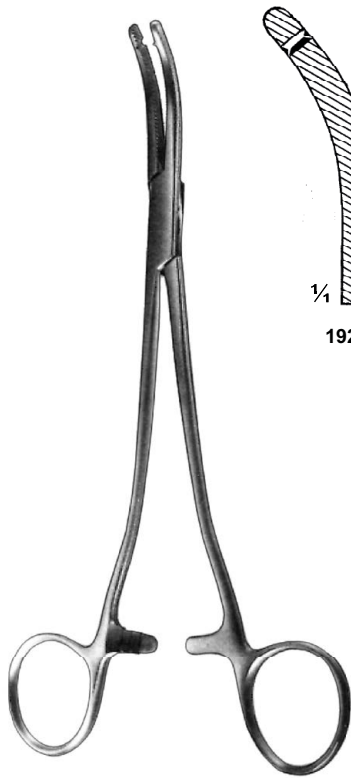

¼

192-01

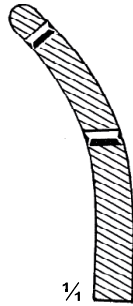

¼

192-02

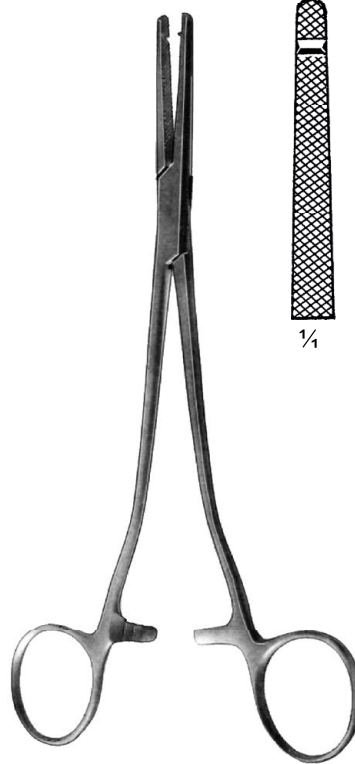

¼

Heaney
192-01 & 192-02
21 cm / 8¼"

Heaney-Rezek
192-03
21 cm / 8¼"

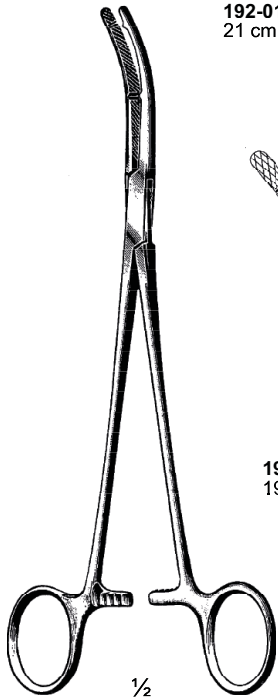

½

Heaney
192-04 To 192-06

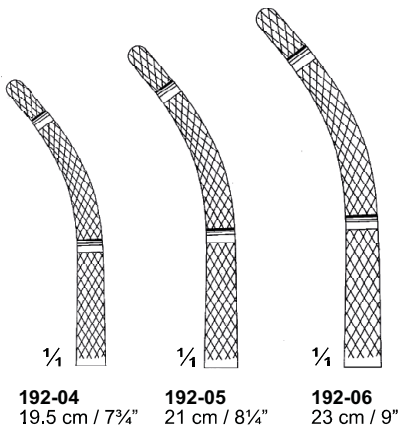

¼

192-04
19.5 cm / 7¾"

¼

192-05
21 cm / 8¼"

¼

192-06
23 cm / 9"

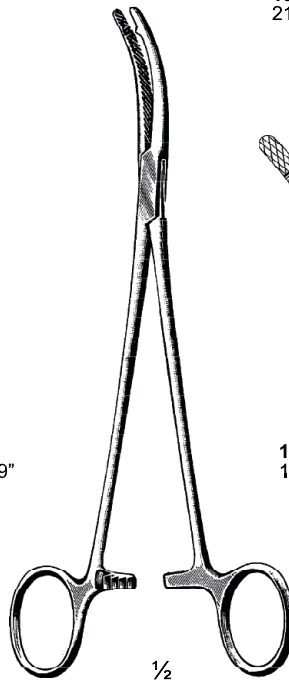

½

Heaney
192-07 To 192-09

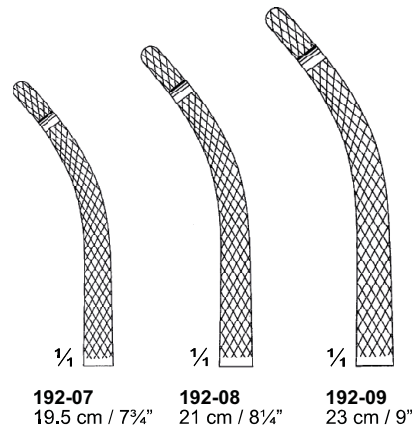

¼

192-07
19.5 cm / 7¾"

¼

192-08
21 cm / 8¼"

¼

192-09
23 cm / 9"

PINÇAS PARA HISTERECTOMIA

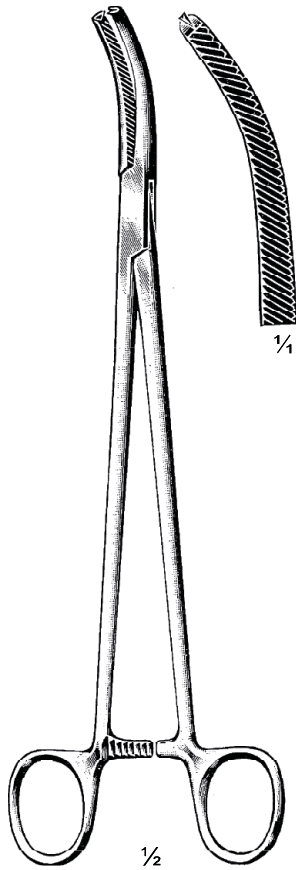

Werheim
195-01
24.5 cm / 9³/₄"
1 X 2 Teeth

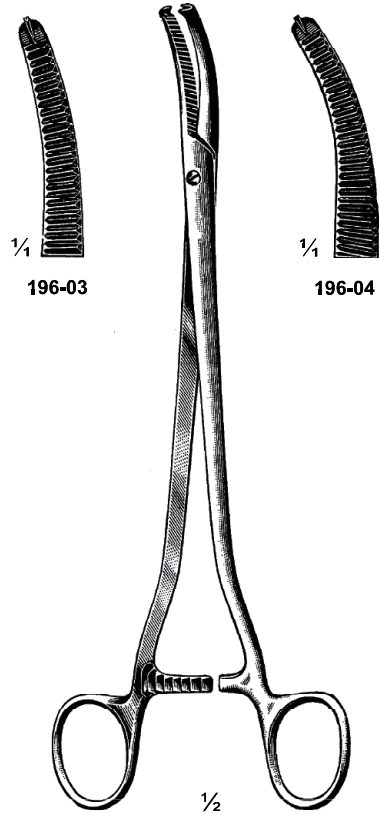

Werheim
196-03 & 196-04
23.5 cm / 9¹/₄"
1 X 2 Teeth

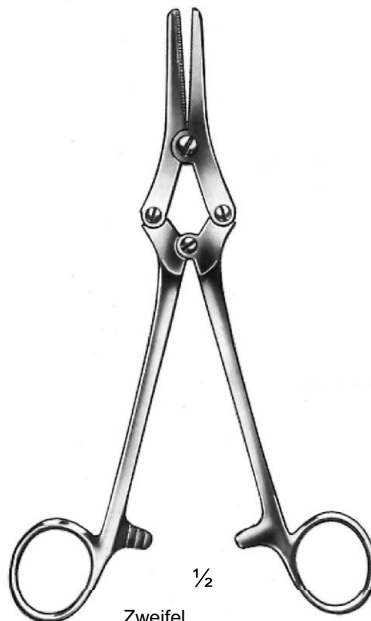

Zweifel
200-01
18 cm / 7"
Compression forceps

PINÇAS PARA HISTERECTOMIA

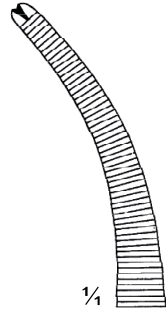

197-01

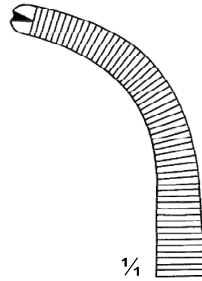

197-02

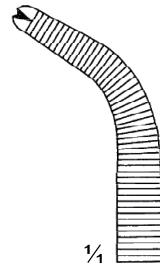

197-03



$\frac{1}{2}$

Wertheim
197-01 To 197-03
23 cm / 9"
1 X 2 Teeth

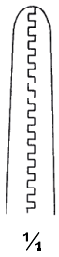

$\frac{1}{4}$

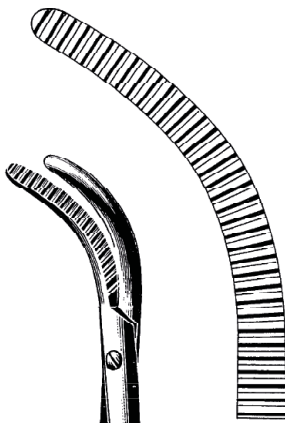

$\frac{1}{4}$

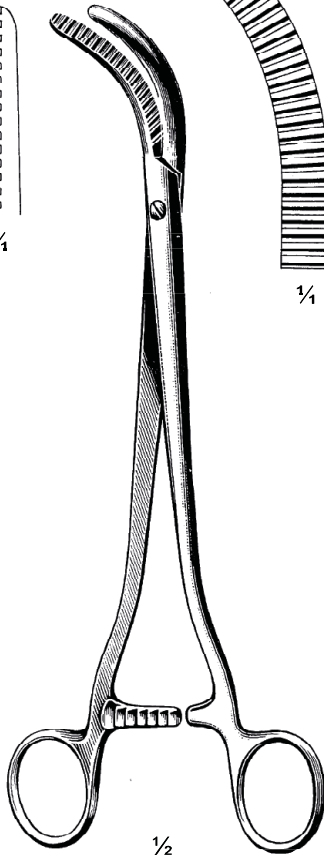

$\frac{1}{2}$

Wertheim
197-04
25 cm / 10"

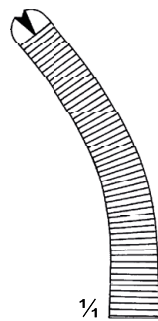

$\frac{1}{4}$

Extra strong

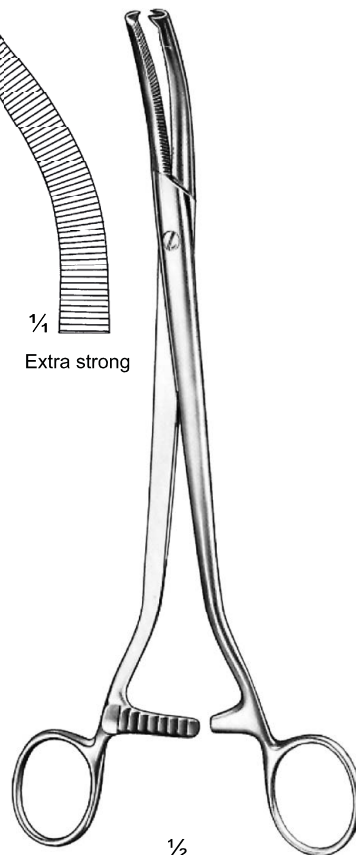

$\frac{1}{2}$

Wertheim
197-05
24 cm / 9½"
1 x 2 Teeth

PINÇAS PARA HISTERECTOMIA

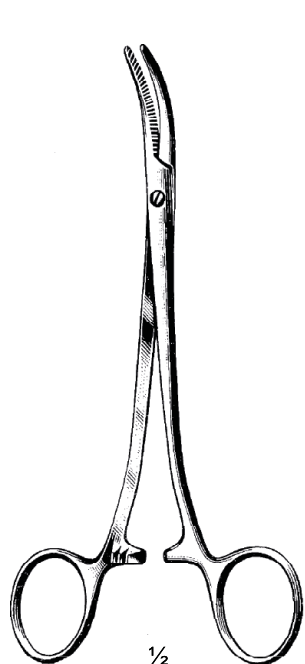

$\frac{1}{2}$
Werheim 198-03
 18 cm / 7"

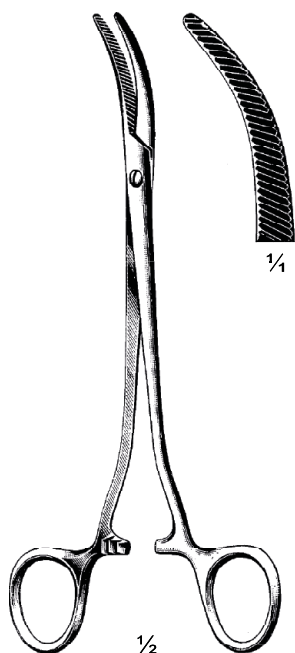

$\frac{1}{2}$
Werheim 198-04
 18.5 cm / 7 1/4"

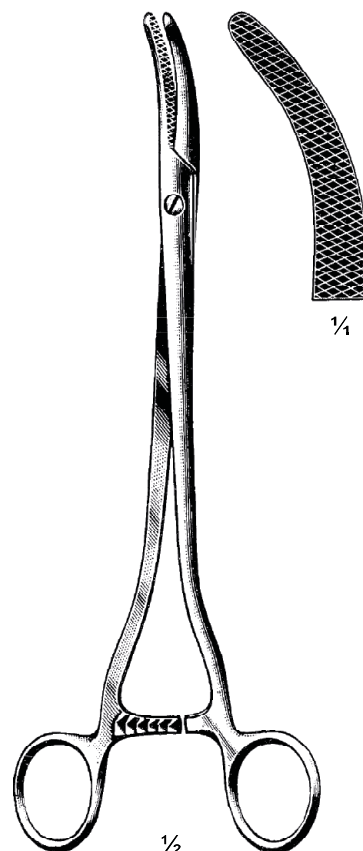

$\frac{1}{2}$
Werheim 198-05
 25 cm / 10"



$\frac{1}{4}$
199-03
 22 cm / 8 3/4"



$\frac{1}{4}$
199-04
 23 cm / 9"

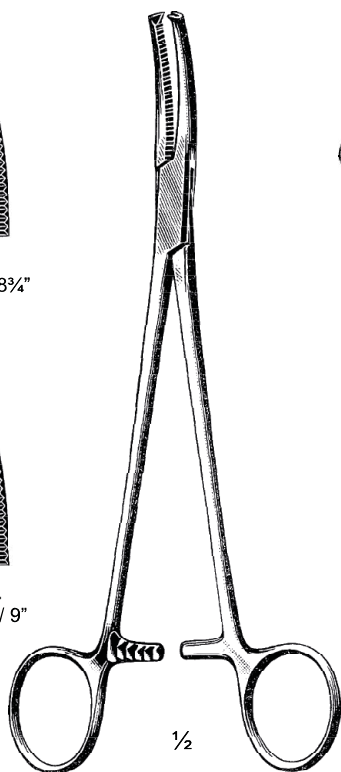

$\frac{1}{2}$
Werheim 199-03 & 199-04
 1 X 2 Teeth

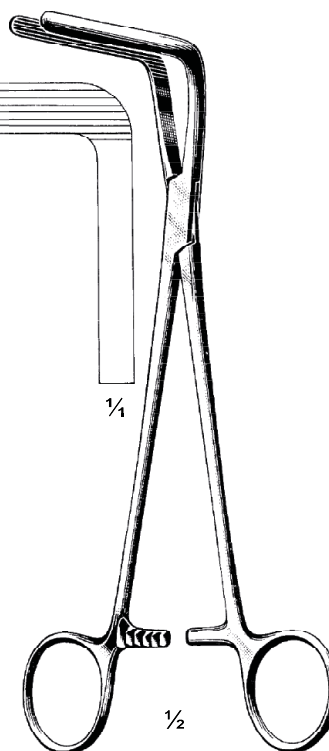
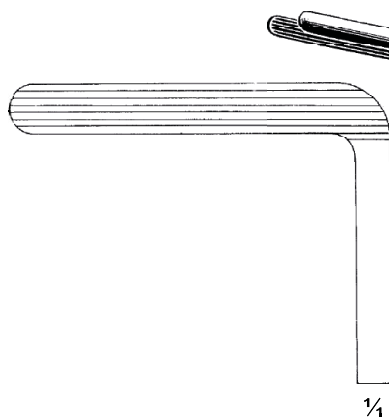

$\frac{1}{2}$
Werheim-Cullen 199-05
 21.5 cm / 8 1/2"

PINÇAS PARA HISTERECTOMIA

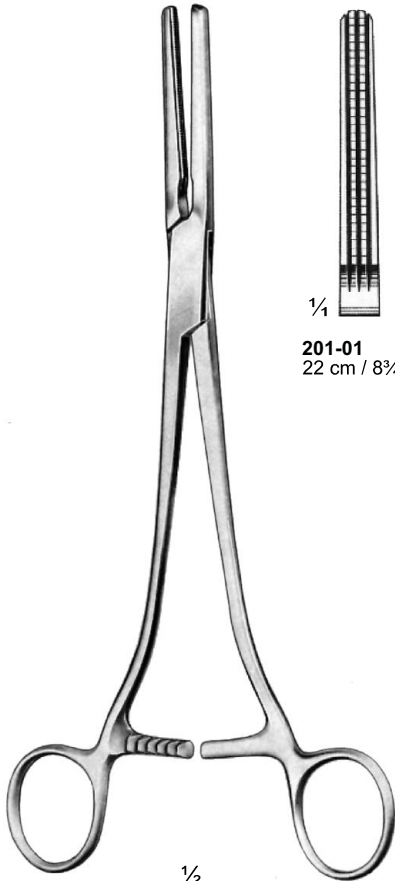

1/2

Rogers
201-01 To 201-09

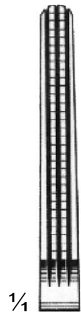

1/4

201-01
22 cm / 8 3/4"

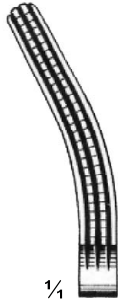

1/4

201-02
21.5 cm / 8 1/2"



1/4

201-03
21 cm / 8 1/4"

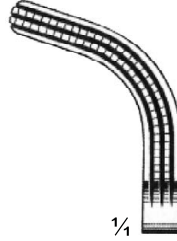

1/4

201-04
20 cm / 8"

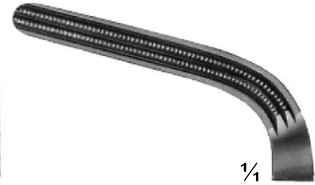

1/4

201-05
20 cm / 8"



1/4

201-06
25 cm / 10"



1/4

201-07
25 cm / 10"

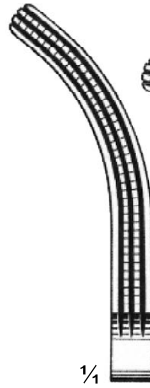

1/4

201-08
24.5 cm / 9 3/4"

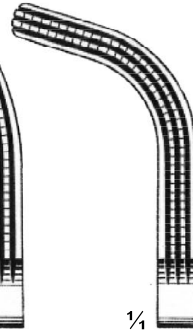

1/4

201-09
23 cm / 9"



1/4

201-10
23 cm / 9"



1/4

201-11
24 cm / 9 1/2"

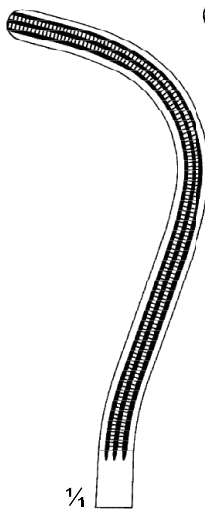

1/4

201-12
23 cm / 9"

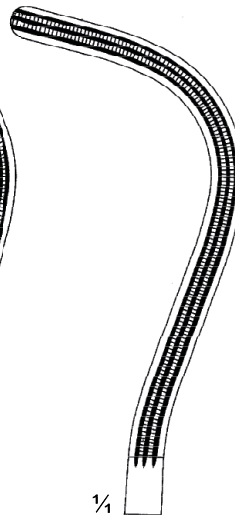

1/4

201-13
24 cm / 9 1/2"



1/2

Guyon
201-10 To 201-13

PINÇAS PARA HISTERECTOMIA

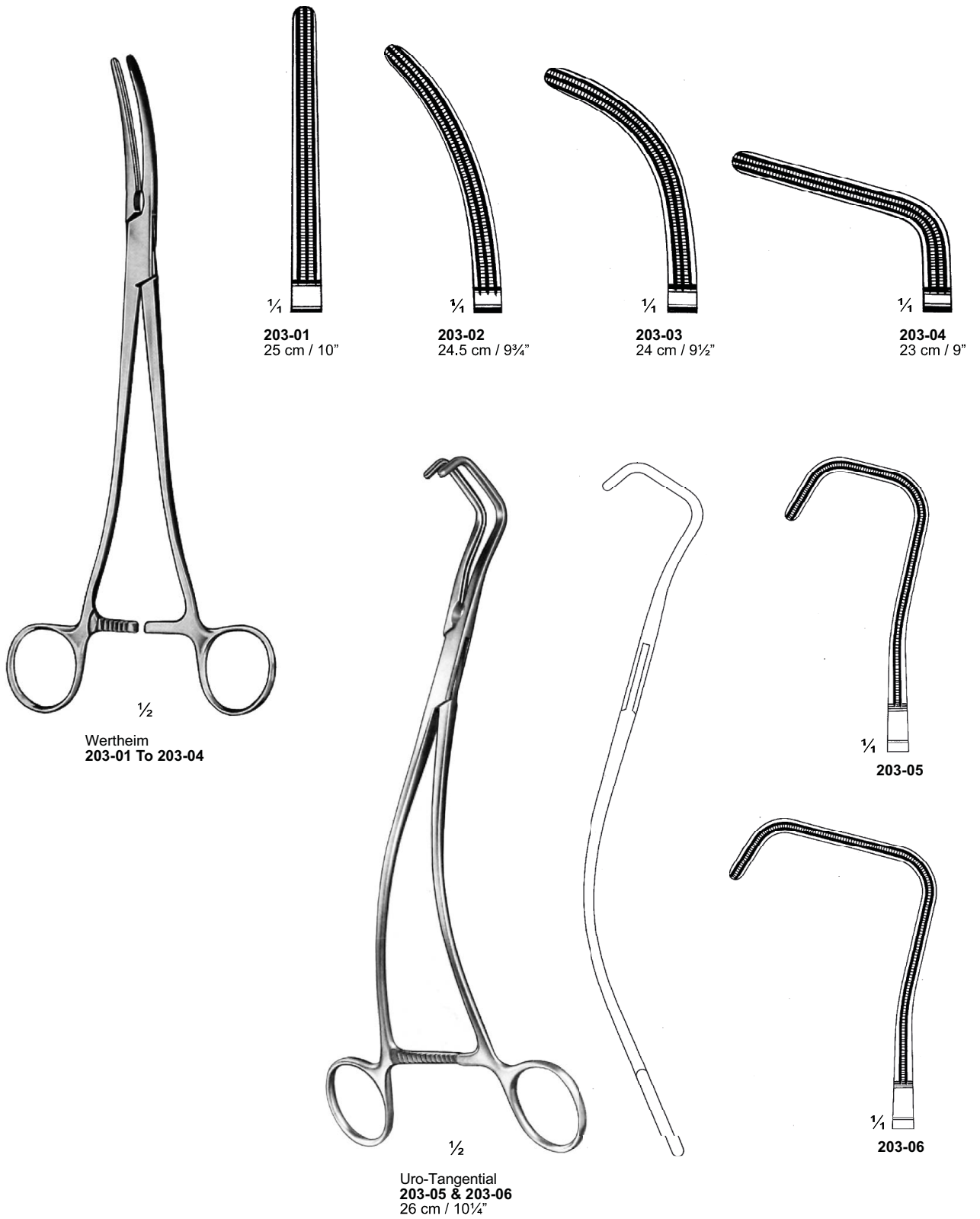

PINÇAS PARA HISTERECTOMIA

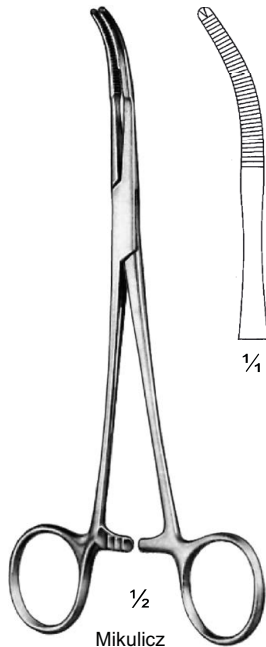

Mikulicz
204-02
18 cm / 7"
1 X 2 Teeth

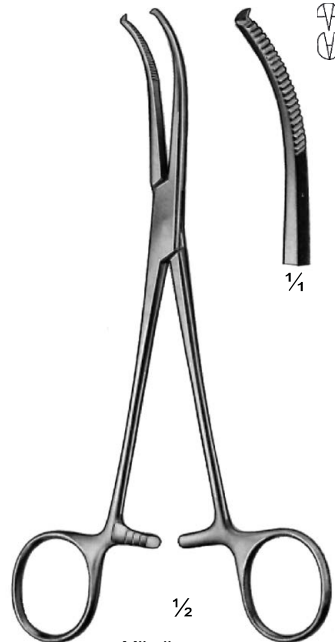

Mikulicz
204-05
18,5 cm / 7 1/4"
1 X 2 Teeth

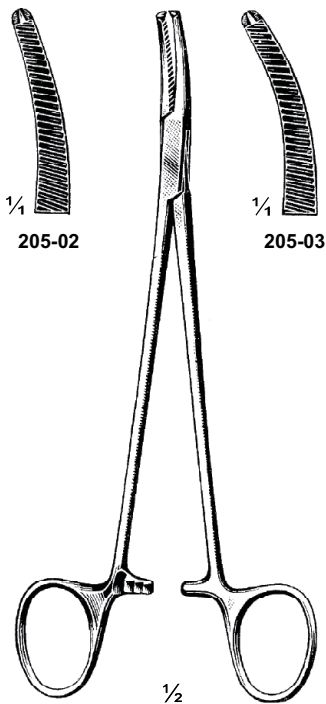

Faure
205-02 & 205-03
20 cm / 8"
1 X 2 Teeth

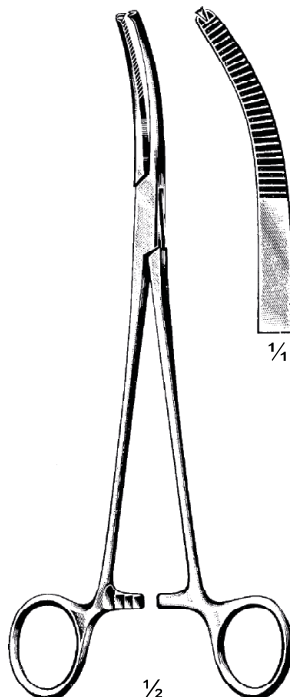

Mikulicz
205-01
20 cm / 8"
1 X 2 Teeth

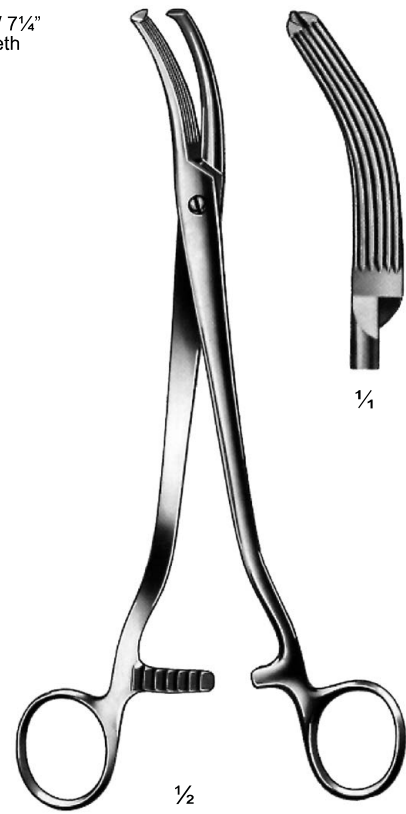

Mikulicz
206-02
23 cm / 9"
1 X 2 Teeth

PINÇAS BULLDOG



1/4

Dieffenbach
207-01 3.5 cm / 1 3/8"
207-02 5 cm / 2"
207-03 6 cm / 2 3/8"
207-04 6.5 cm / 2 1/2"
207-05 7 cm / 2 3/4"
207-06 8 cm / 3"



1/4

Dieffenbach
207-07 3.5 cm / 1 3/8"
207-08 5 cm / 2"
207-09 6 cm / 2 3/8"
207-10 6.5 cm / 2 1/2"
207-11 7 cm / 2 3/4"
207-12 8 cm / 3"



1/4

Johns-Hopkins
207-25 4 cm / 1 1/2"
207-26 5 cm / 2"
207-27 6 cm / 2 3/8"
207-28 6.5 cm / 2 1/2"
207-29 7 cm / 2 3/4"
207-30 8 cm / 3"
207-31 9 cm / 3 1/2"



1/4

Johns-Hopkins
207-32 4 cm / 1 1/2"
207-33 5 cm / 2"
207-34 6 cm / 2 3/8"
207-35 6.5 cm / 2 1/2"
207-36 7 cm / 2 3/4"
207-37 8 cm / 3"
207-38 9 cm / 3 1/2"



1/4

Ultra-Micro
208-13 3 cm / 1 1/4"
208-14 3.5 cm / 1 3/8"
208-15 4 cm / 1 1/2"
208-16 5 cm / 2"



1/4

Ultra-Micro
208-17 3 cm / 1 1/4"
208-18 3.5 cm / 1 3/8"
208-19 4 cm / 1 1/2"
208-20 5 cm / 2"



1/4
Dietrich

208-01 To 208-06



1/4

208-01
 5 cm / 2"
 8 mm Jaw

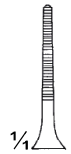

1/4

208-02
 5 cm / 2"
 12 mm Jaw

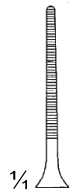

1/4

208-03
 6 cm / 2 3/8"
 20 mm Jaw



1/4

208-04
 5 cm / 2"
 8 mm Jaw

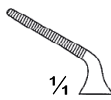

1/4

208-05
 5 cm / 2"
 12 mm Jaw

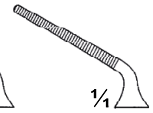

1/4

208-06
 6 cm / 2 3/8"
 20 mm Jaw

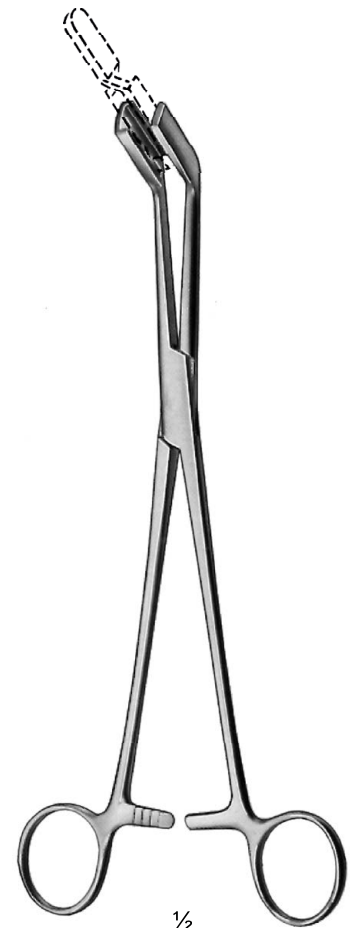

1/2

Johns-Hopkins
208-27
 24.5 cm / 9 3/4"
 For applying and
 removing bulldog clamps

PINÇAS PARA TAMPÕES



Ulrich
228-01 To 228-03



1/4

228-01
22 cm / 8 3/4"



1/4

228-02
25 cm / 10"

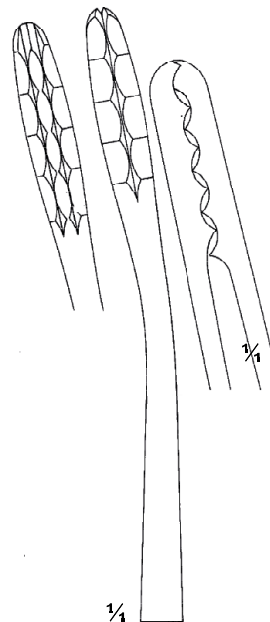

1/4

228-03
27 cm / 10 1/4"

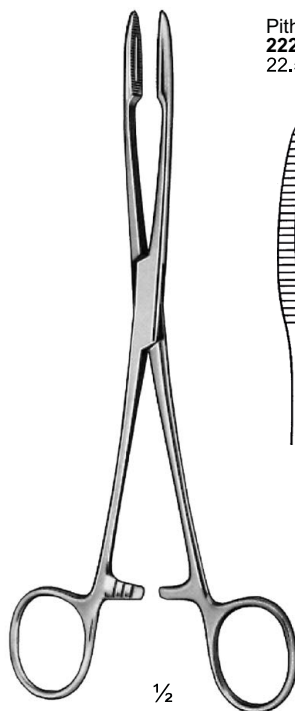

1/2

Gross
222-12 14.5 cm / 5 3/4"
222-13 16 cm / 6 1/4"
222-14 18 cm / 7"
222-15 20 cm / 8"

Pitha
222-03
22.5 cm / 8 3/4"



1/4

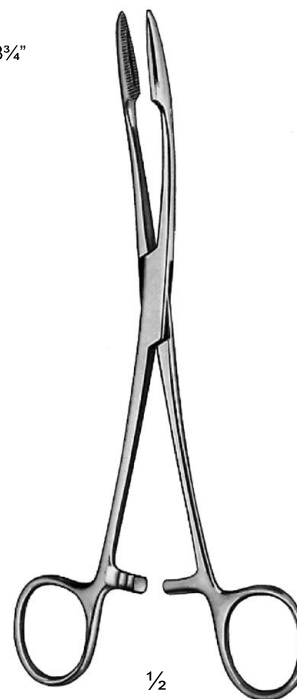

1/2

Gross
222-16 14.5 cm / 5 3/4"
222-17 16 cm / 6 1/4"
222-18 18 cm / 7"
222-19 20 cm / 8"

PINÇAS PARA TAMPÕES

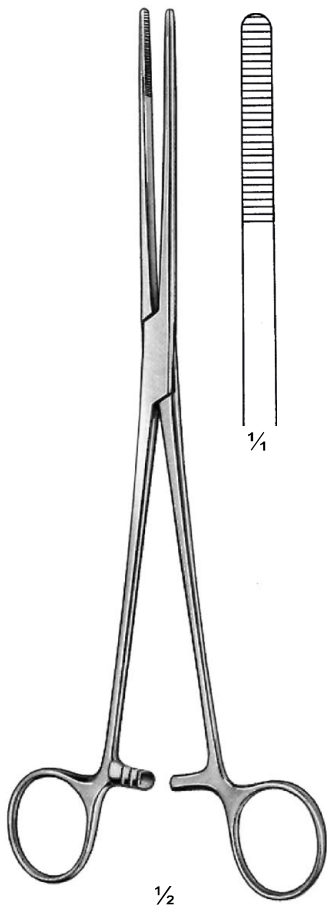

Bozemann
224-01
26 cm / 10 1/4"

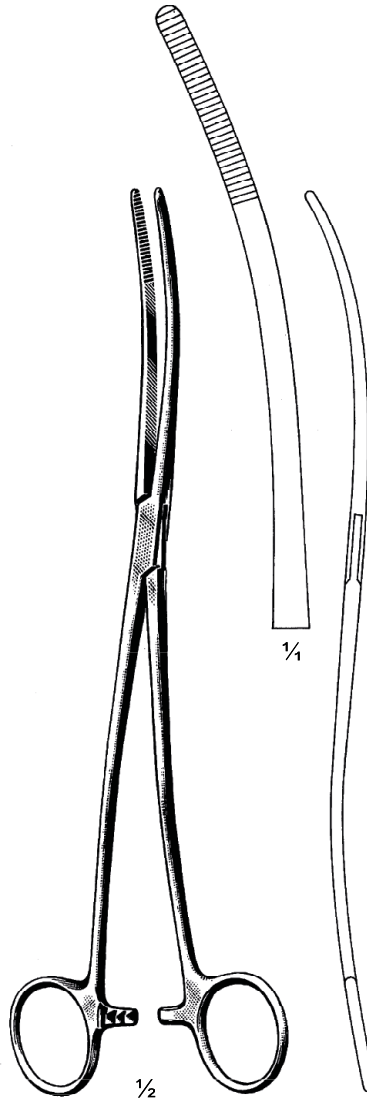

Bozemann
224-02
26 cm / 10 1/4"



Cheron
225-06
25 cm / 10"

PINÇAS PARA TAMPÕES

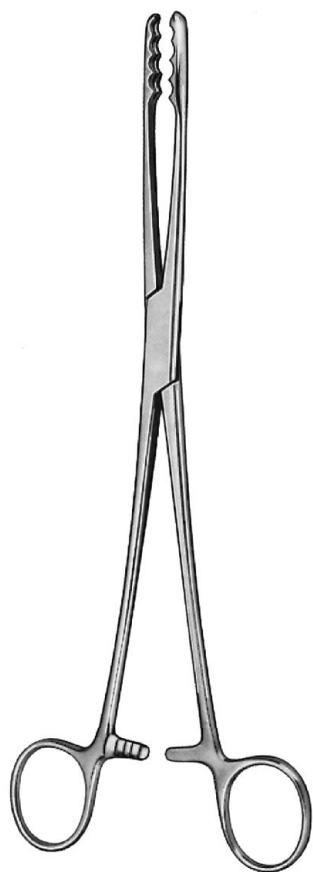

Ulrich
227-01 To 227-03

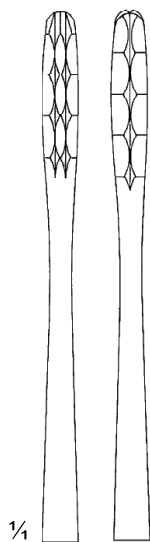

227-01
22 cm / 8³/₄"

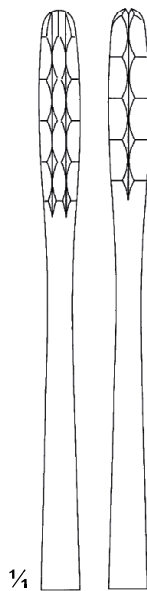

227-02
25 cm / 10"

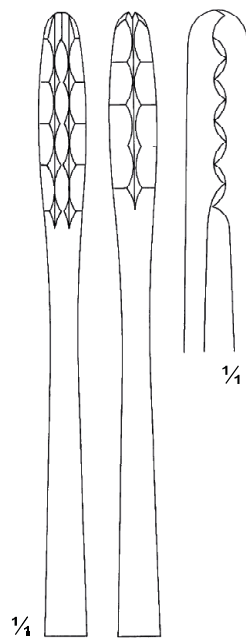

227-03
27 cm / 10³/₄"

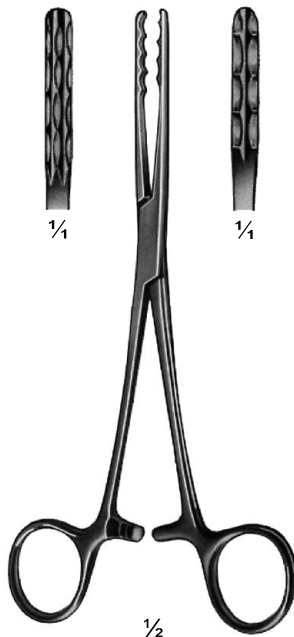
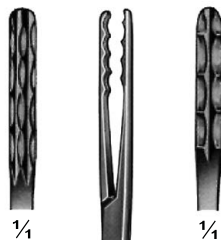

Ulrich
227-04
18 cm / 7"

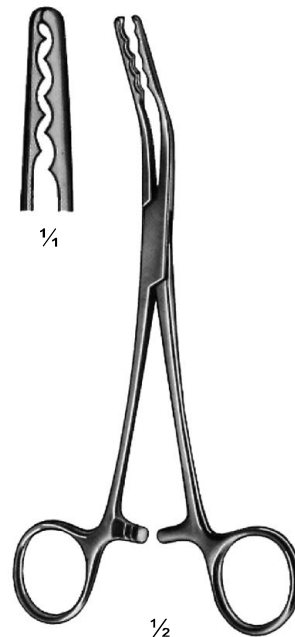

Ulrich
227-05
18 cm / 7"

PINÇAS PARA CARTILAGEM

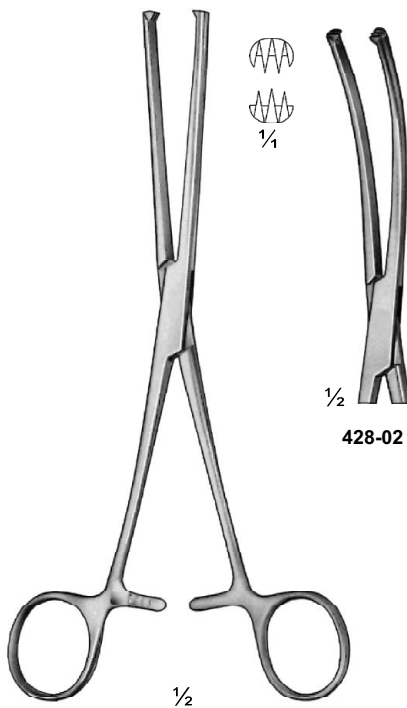

Bircher
428-01 Str
428-02 Cur
20 cm / 8"
3 X 4 Teeth

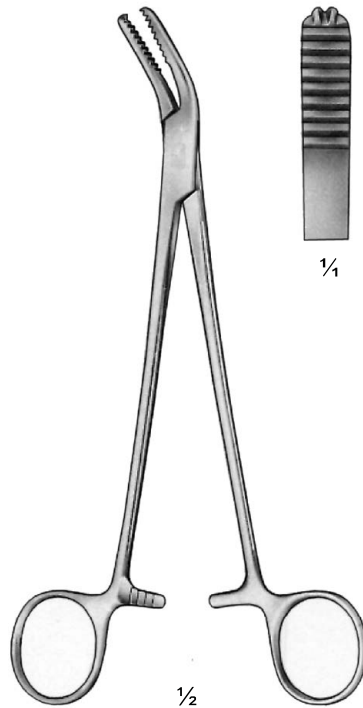

Weller
428-03
20 cm / 8"

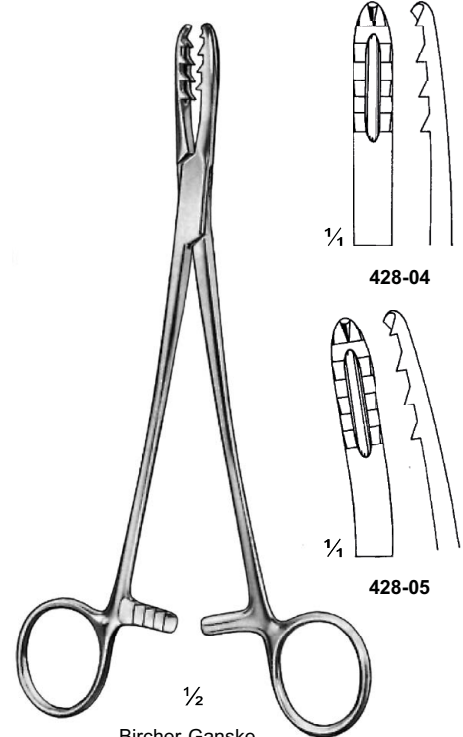

Bircher-Ganske
428-04 & 428-05
20 cm / 8"

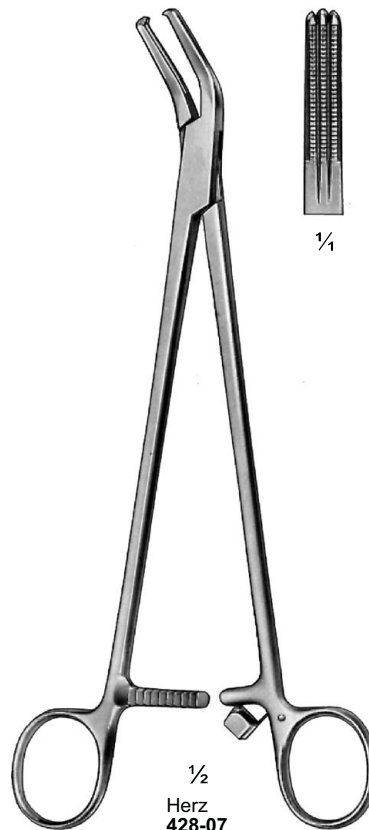

Herz
428-07
23 cm / 9"

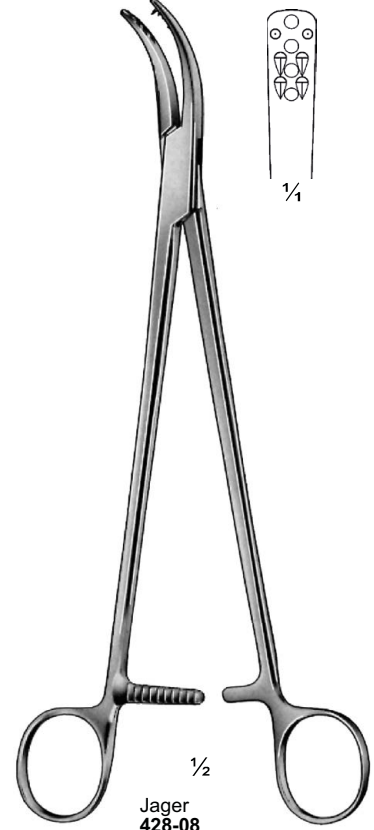

Jager
428-08
23.5 cm / 9 1/4"

PINÇAS PARA TENDÃO

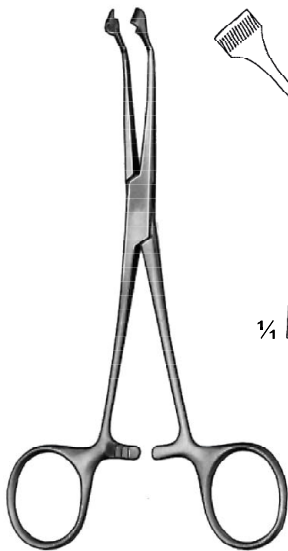

Herz
431-04 & 431-05
15cm / 6"

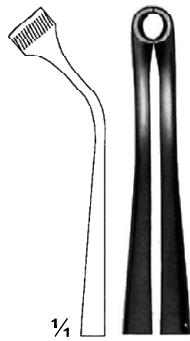

1/4

431-04

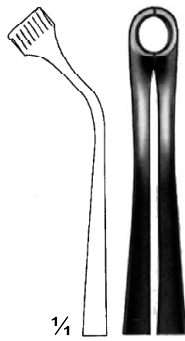

1/4

431-05



1/4

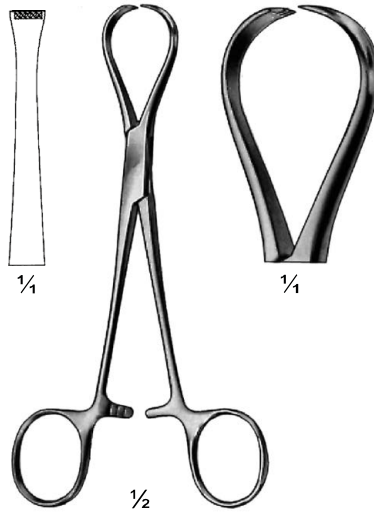

1/2

Jackson
432-02
15 cm / 6"
4 X 5 Teeth

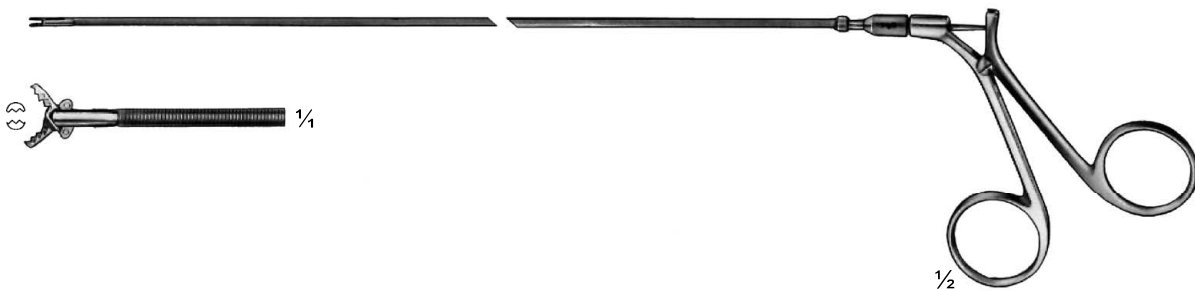

1/2

Jager
431-06
Flexible shaft 27.5 cm / 10 3/4"

PINÇAS DE APREENSÃO ÓSSEA



Lewin
503-08
18cm / 7"



Steinhauser
503-09
13cm / 5 1/8"

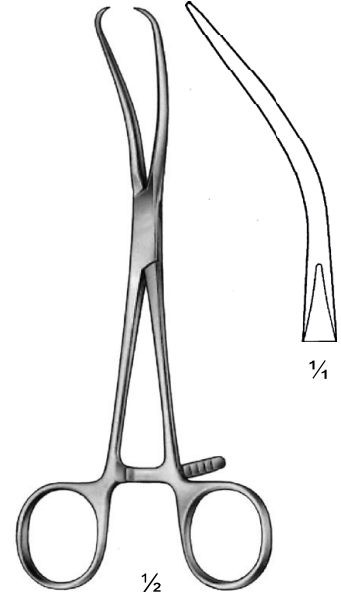

Reill
504-02
17 cm / 6 3/4"

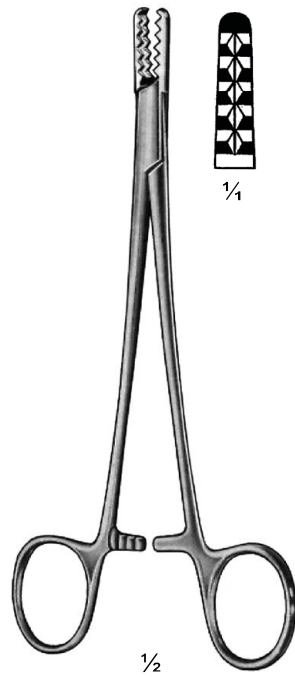

505-04
19cm / 7 1/2"

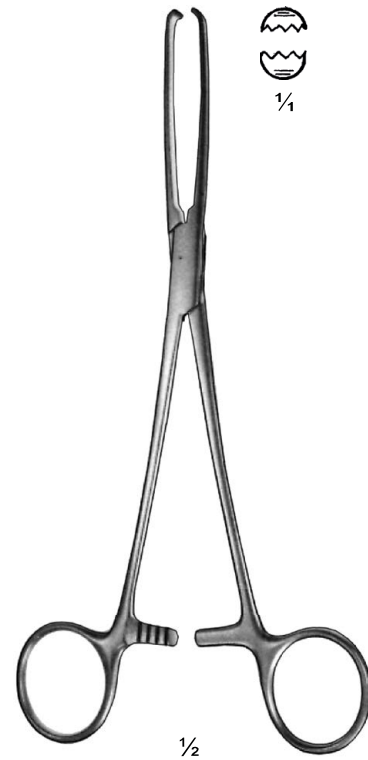

Perman
505-06
21 cm / 8 1/4"

PINÇAS DE APREENSÃO ÓSSEA

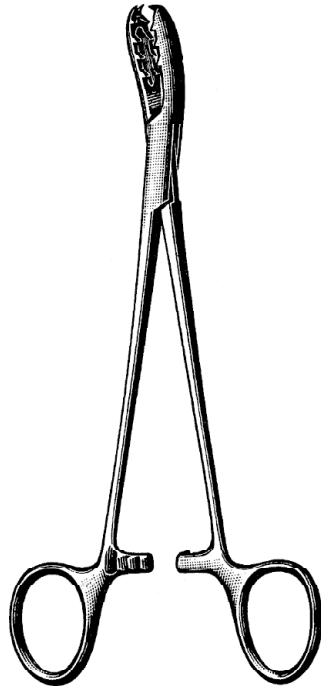

Bircher-Granske
506-01
20 cm / 8"

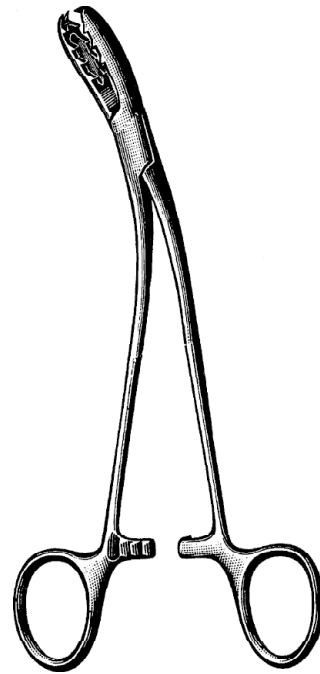

Bircher-Granske
506-02
20 cm / 8"



¼



½
Van Buren
506-08
23 cm / 9"



½
Frosch
507-01 Opening 10 mm
14 cm / 5½"

PINÇAS DE APREENSÃO ÓSSEA

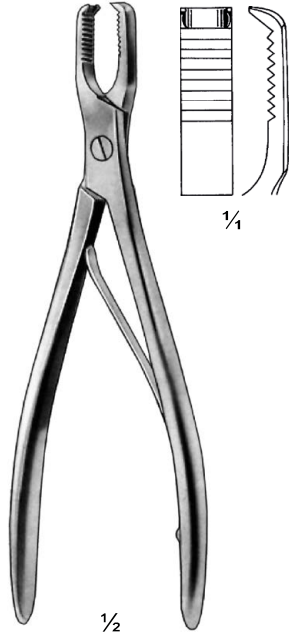

$\frac{1}{2}$
Frosch
507-02
18 cm / 7"

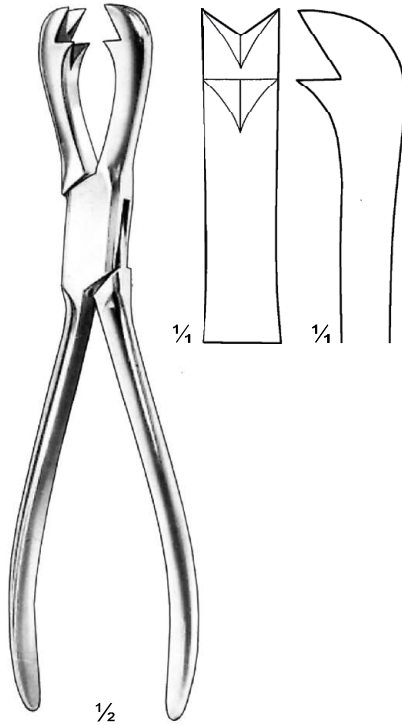

$\frac{1}{2}$
Fergusson
507-03
21 cm / 8 $\frac{1}{4}$ "



$\frac{1}{2}$
Rowe-Harrison
507-04
20 cm / 8"

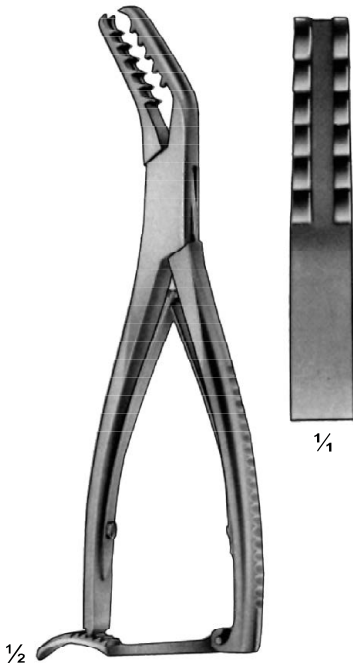

$\frac{1}{2}$
Semb
507-05
19 cm / 7 $\frac{1}{2}$ "

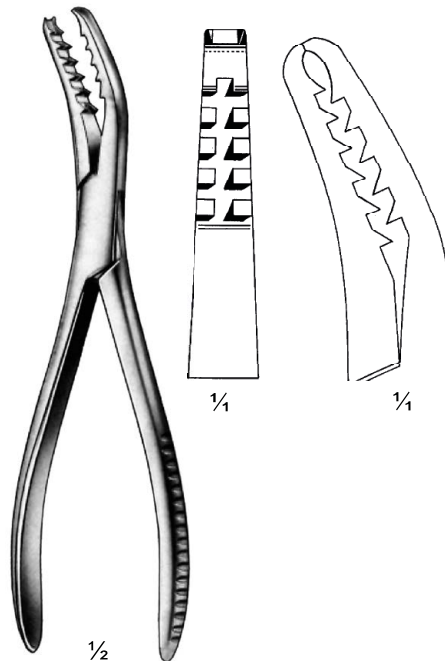

$\frac{1}{2}$
Semb
506-06
19 cm / 7 $\frac{1}{2}$ "

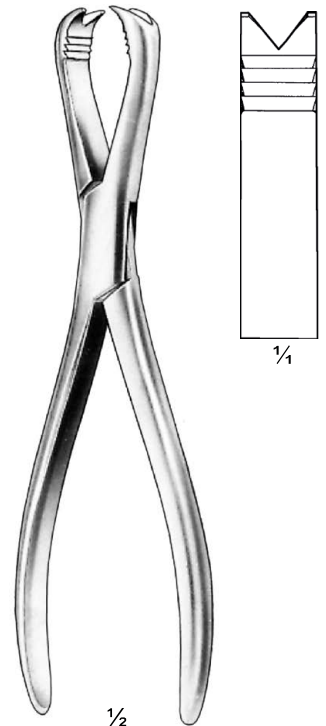

$\frac{1}{2}$
Langenbeck
507-07
21 cm / 8 $\frac{1}{4}$ "

PINÇAS DE APREENSÃO ÓSSEA

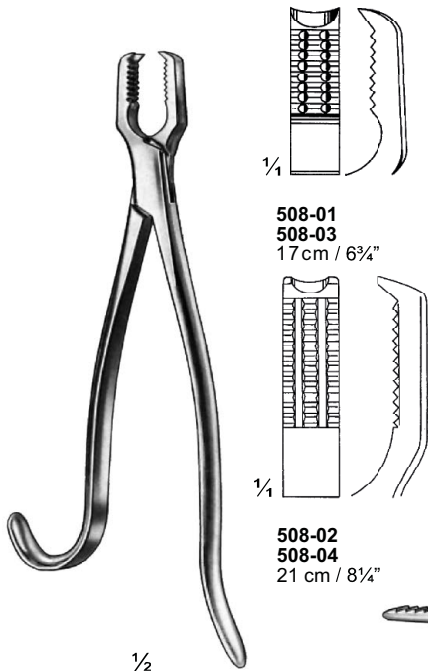

508-01
508-03
17 cm / 6³/₄"

508-02
508-04
21 cm / 8¹/₄"

Kern $\frac{1}{2}$
508-01 & 508-02

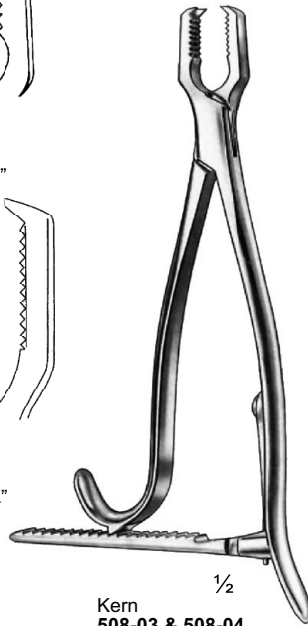

Kern $\frac{1}{2}$
508-03 & 508-04



Kern-Mini
508-05
14 cm / 5¹/₂"



Kern-Mini
508-06
14 cm / 5¹/₂"



Kern-Mini
508-07
15 cm / 6"

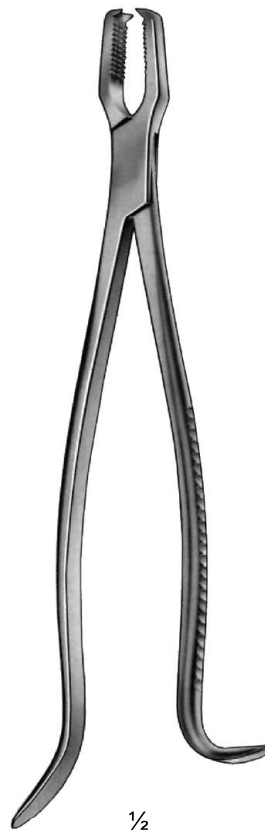

Kern-Lane
508-08
24 cm / 9¹/₂"



Kern-Lane
508-09
24 cm / 9¹/₂"

PINÇAS DE APREENSÃO ÓSSEA

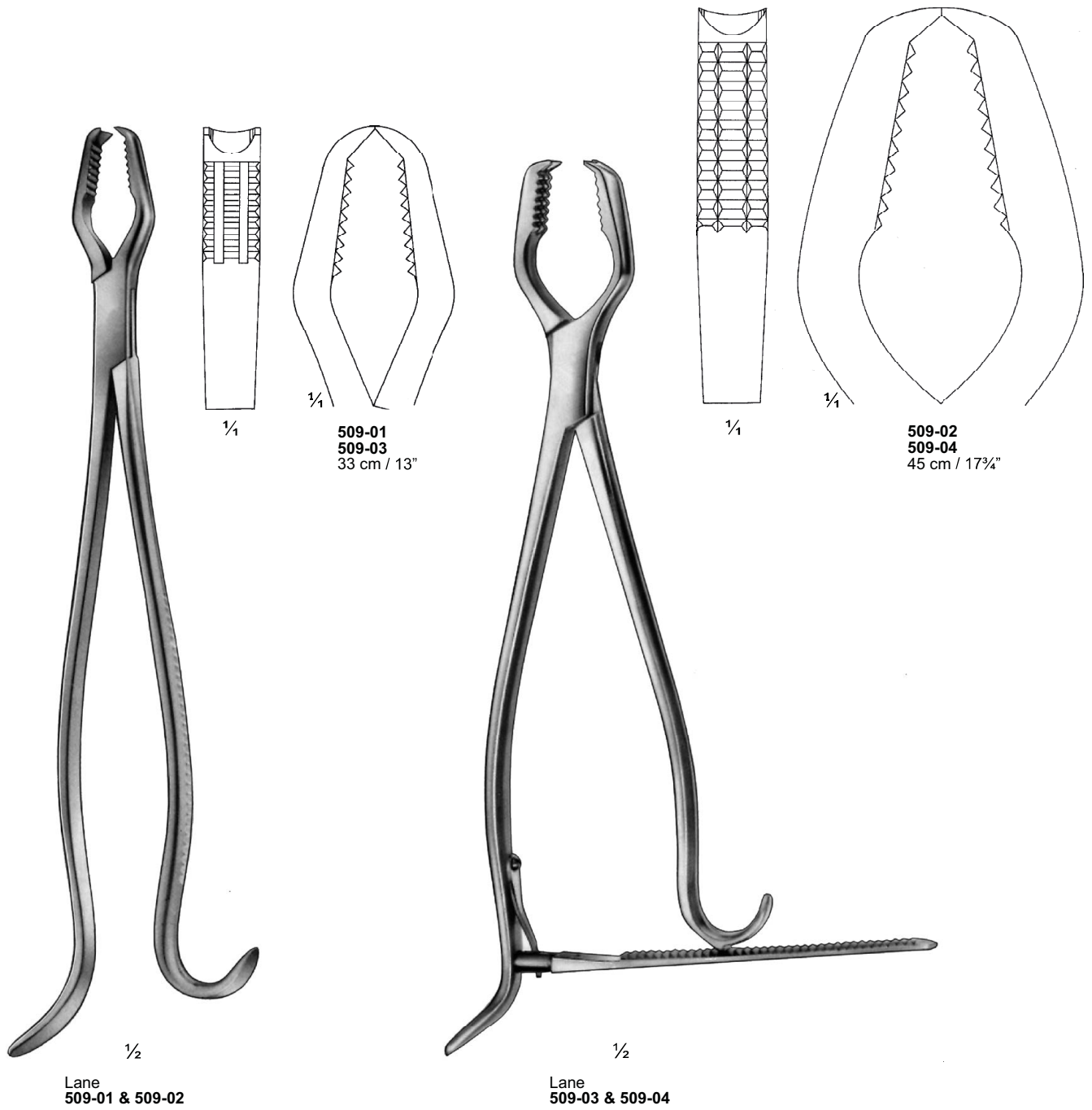

PINÇAS DE APREENSÃO ÓSSEA



1/2

Farabeuf
510-01 & 510-02

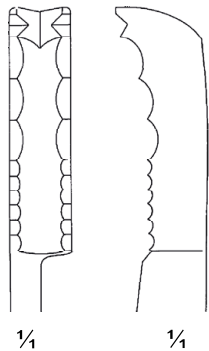

1/4

1/4



1/4

510-01
23 cm / 9"
9 mm



1/4

510-02
26 cm / 10 1/4"
11 mm



1/2

Tuffier
510-03
27 cm / 10 1/2"

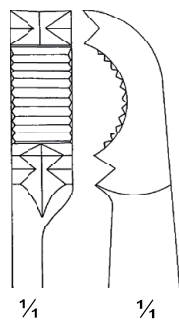

1/4

1/4



1/2

Farabeuf-Lambotte
510-04
26 cm / 10 1/4"

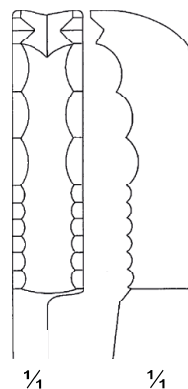

1/4

1/4



Farabeuf-Lambotte
510-05
15 cm / 6"

PINÇAS DE APREENSÃO ÓSSEA

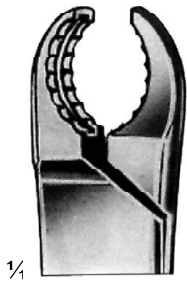

512-01
512-04
23 cm / 9"



512-02
512-05
25 cm / 10"

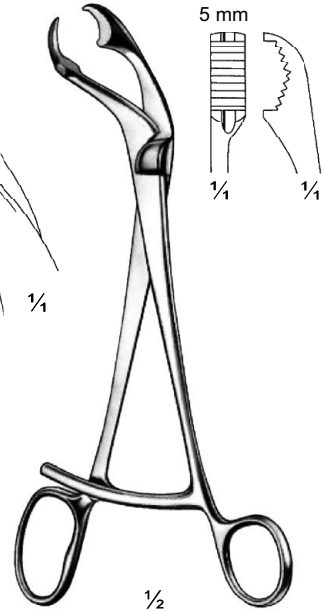
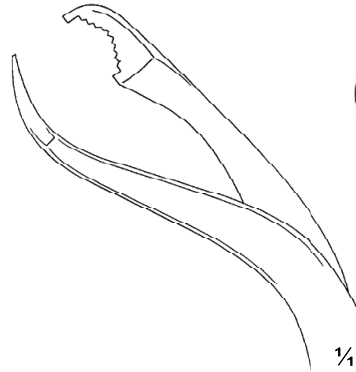

1/2
Verbrugge
512-07
17cm / 6 3/4"

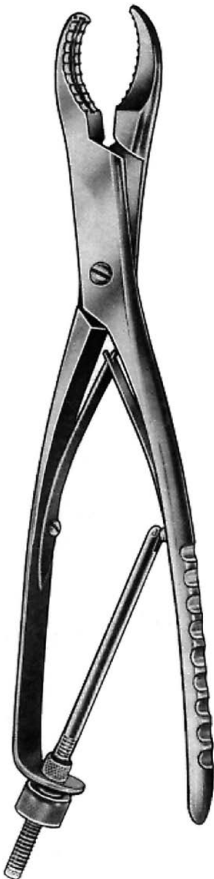

Ulrich
512-01 To 512-03

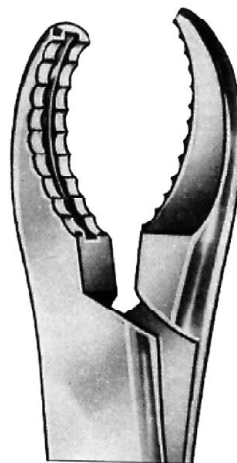

512-03
512-06
28 cm / 11"



Ulrich
512-04 To 512-06

PINÇAS DE APREENSÃO ÓSSEA

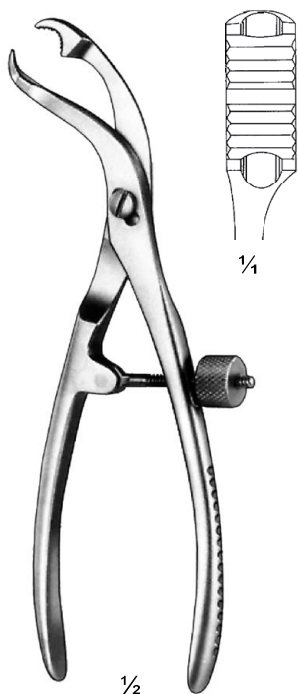
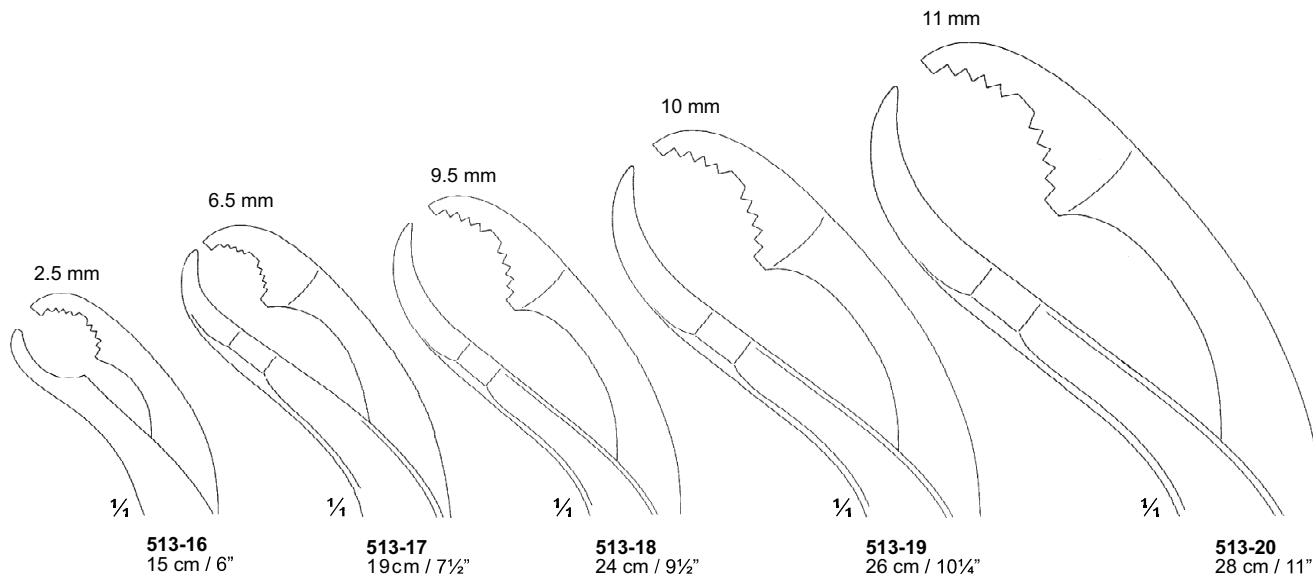

Self-Centering
513-16 To 513-20

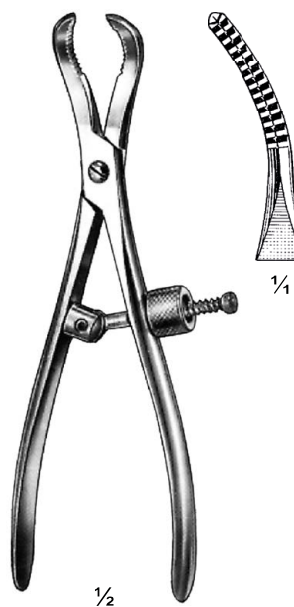

Espanhola
513-11 16cm / 6¼"
513-12 18 cm / 7"
513-13 20 cm / 8"
513-14 22 cm / 8¾"
513-15 24 cm / 9½"

PINÇAS DE APREENSÃO ÓSSEA

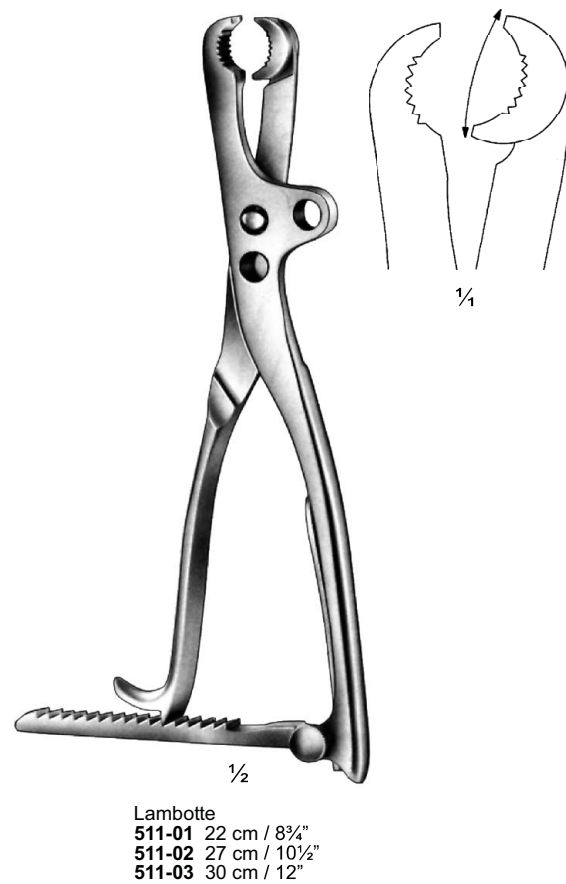
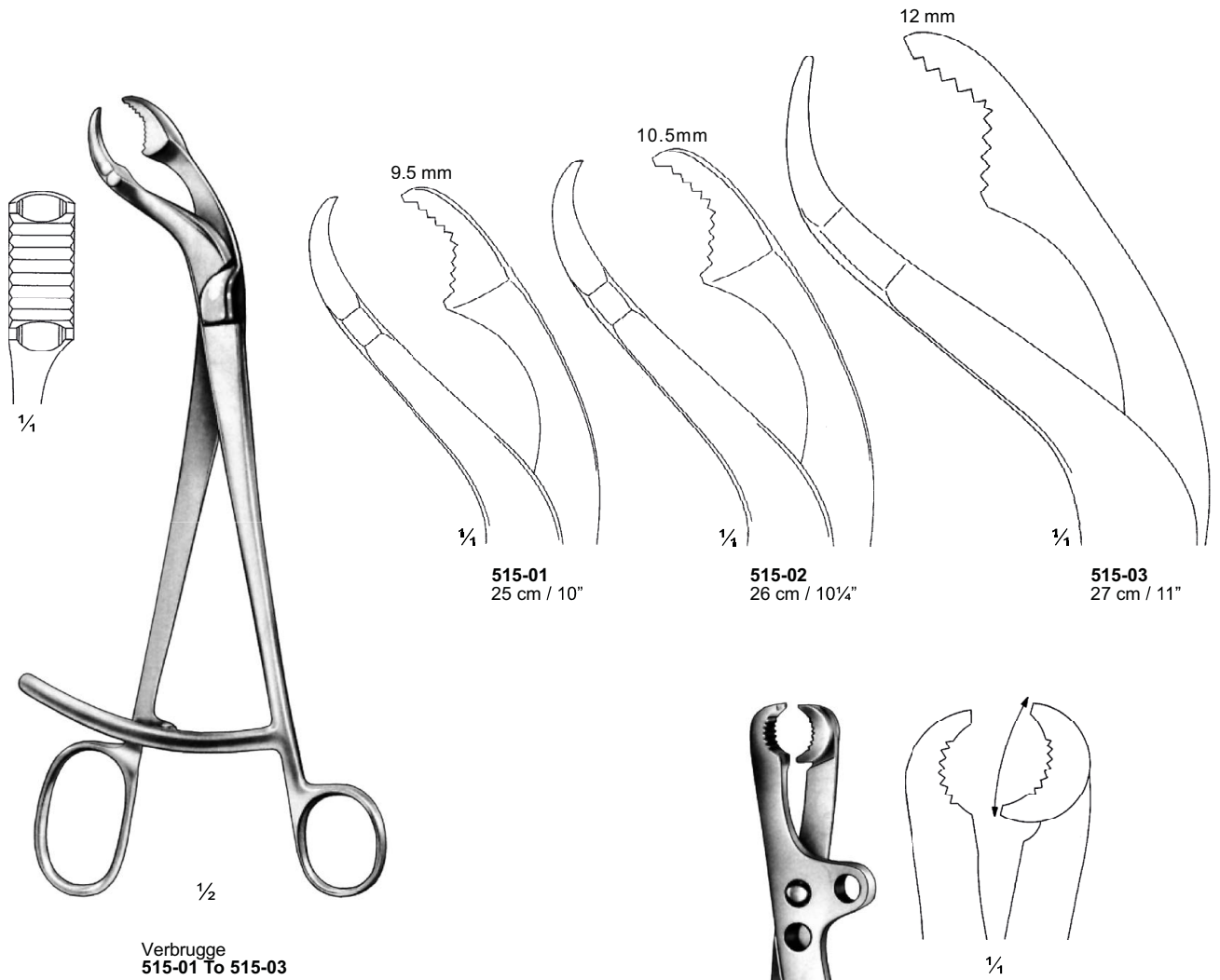

PINÇAS DE APREENSÃO ÓSSEA

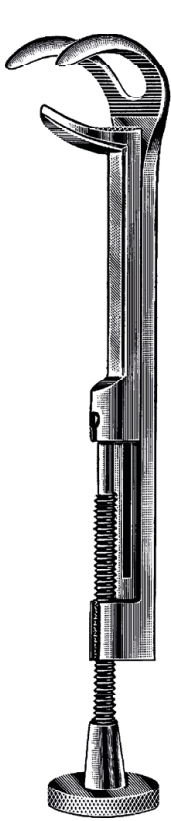

Lowmann
516-04 To 516-06

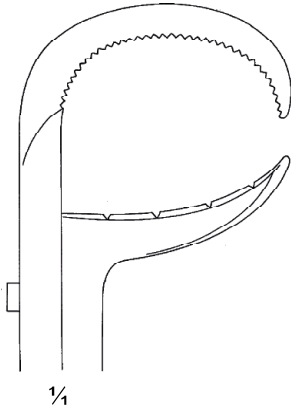

1/4

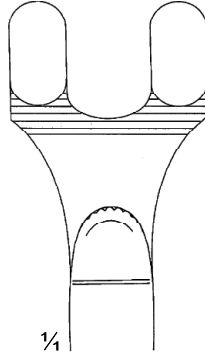

1/4

516-01
516-04
18 cm / 7"

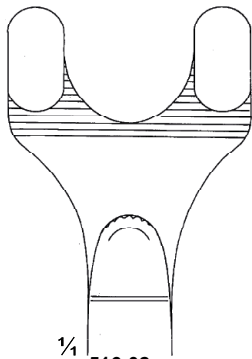

1/4

516-02
516-05
20 cm / 8"

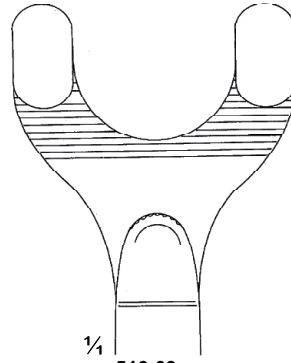

1/4

516-03
516-06
22 cm / 8 3/4"

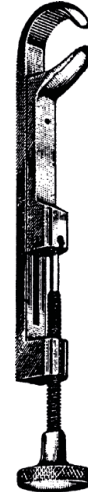

Lowmann
516-07 12 cm / 4 3/4"
516-08 15 cm / 6"
516-09 18 cm / 7"
516-10 20 cm / 8"
516-11 22 cm / 8 3/4"

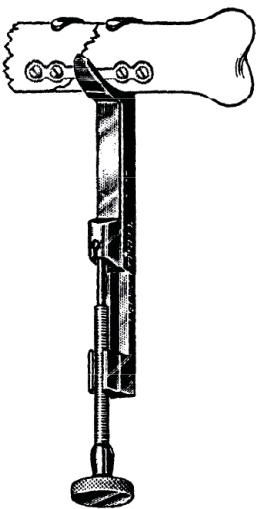

Lowmann
516-12 12 cm / 4 3/4"
516-13 15 cm / 6"

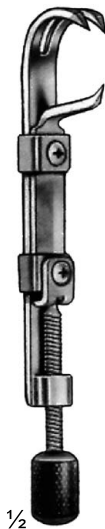

1/2

Bunnell-Howard
517-17
15 cm / 6"

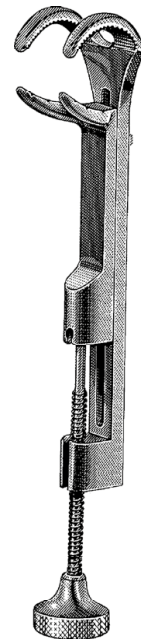
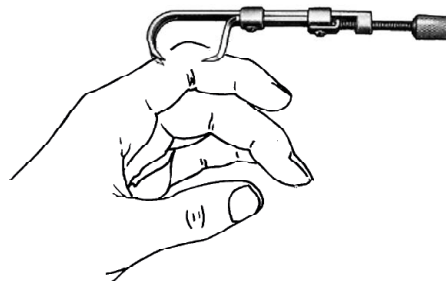

Lambert-Lowmann
517-12 12 cm / 4 3/4"
517-13 15 cm / 6"
517-14 18 cm / 7"
517-15 20 cm / 8"
517-16 22 cm / 8 3/4"

PINÇAS GESSO E PINÇA PARA GRAMPO

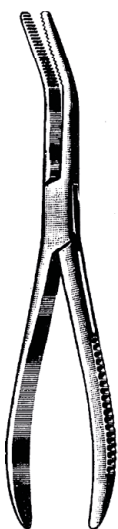

Farabeuf
112-01 18 cm / 7"
112-02 20 cm / 8"
112-03 24 cm / 9½"

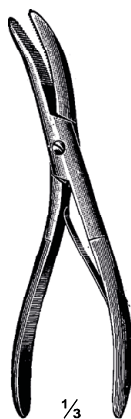

Wolff
112-04
 18 cm / 7"

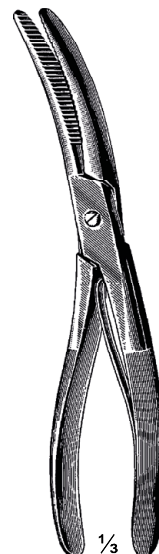

Wolff
112-05
 24 cm / 9½"

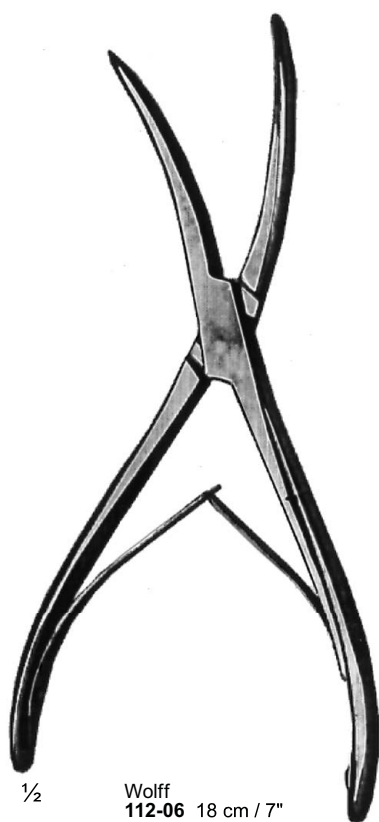

½
 Wolff
112-06 18 cm / 7"
112-07 20 cm / 8"
112-08 22 cm / 8¾"
112-09 24 cm / 9½"
112-10 26 cm / 10¼"



½
 Mason
112-11 18 cm / 7"
112-12 20 cm / 8"
112-13 23 cm / 9"



½
 Michel
293-06
 12.5 cm / 5"

PINÇA PARA LÍNGUA E PINÇA PARA CATETER

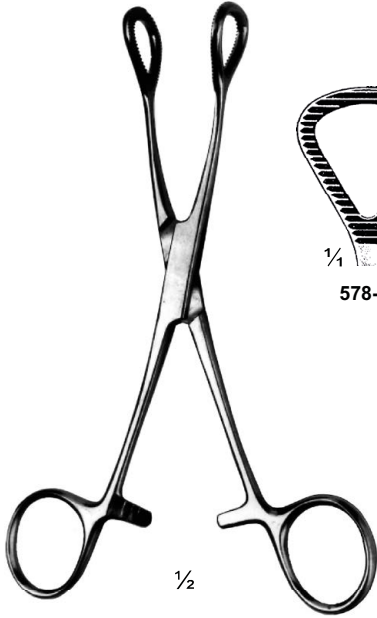

Guy
578-21
19cm / 7½"

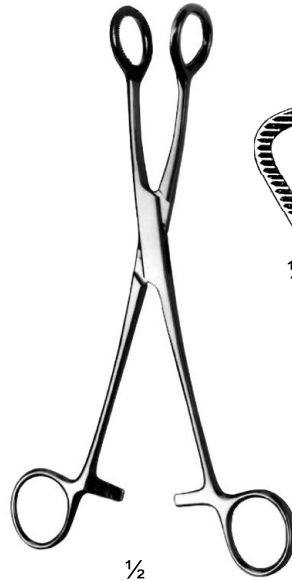

Collin
578-1 To 578-18

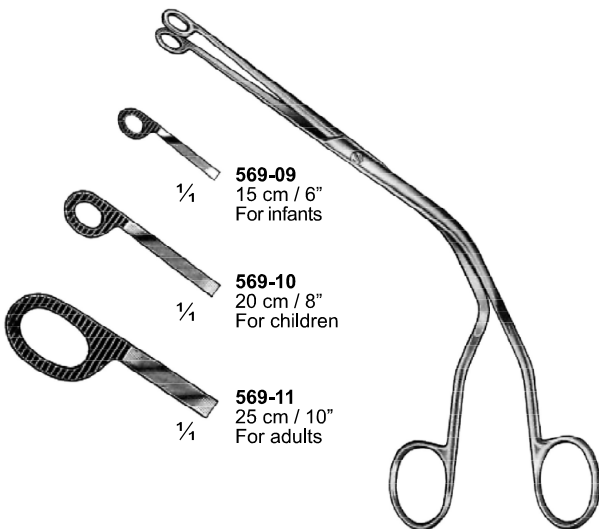

Magil
569-09 To 569-11

PINÇAS PARA LARINGE

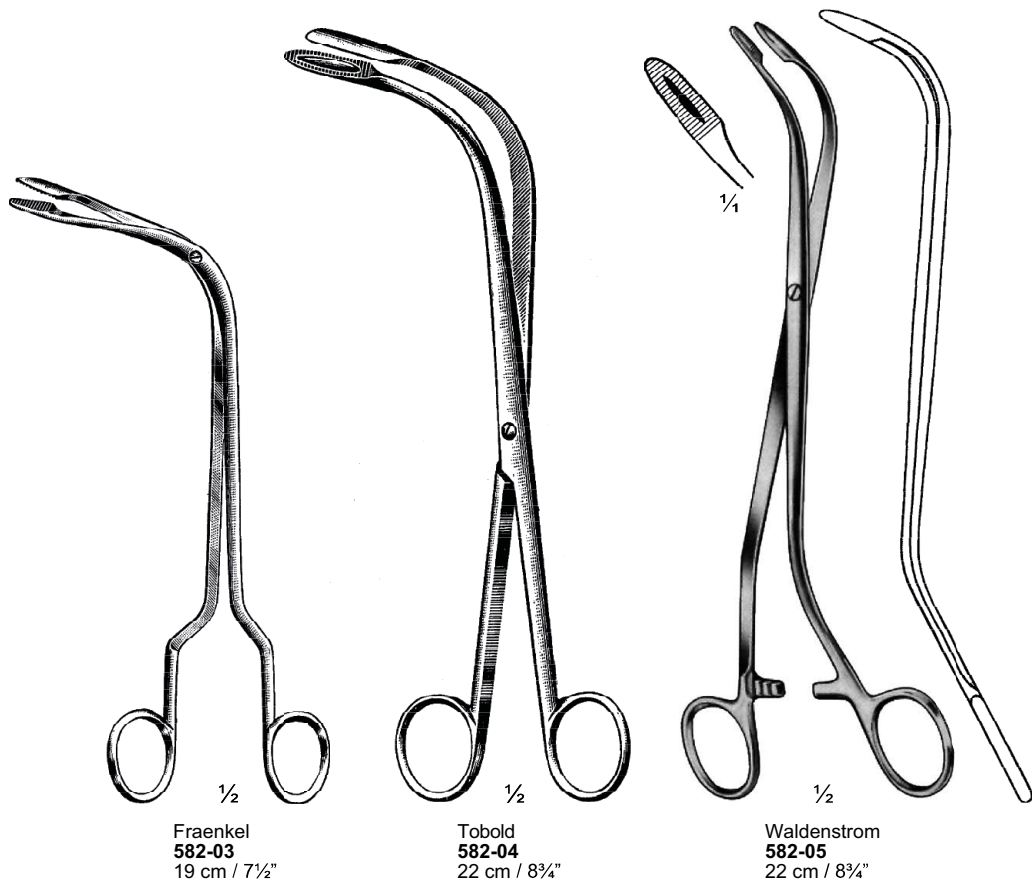

PINÇAS PARA LARINGE

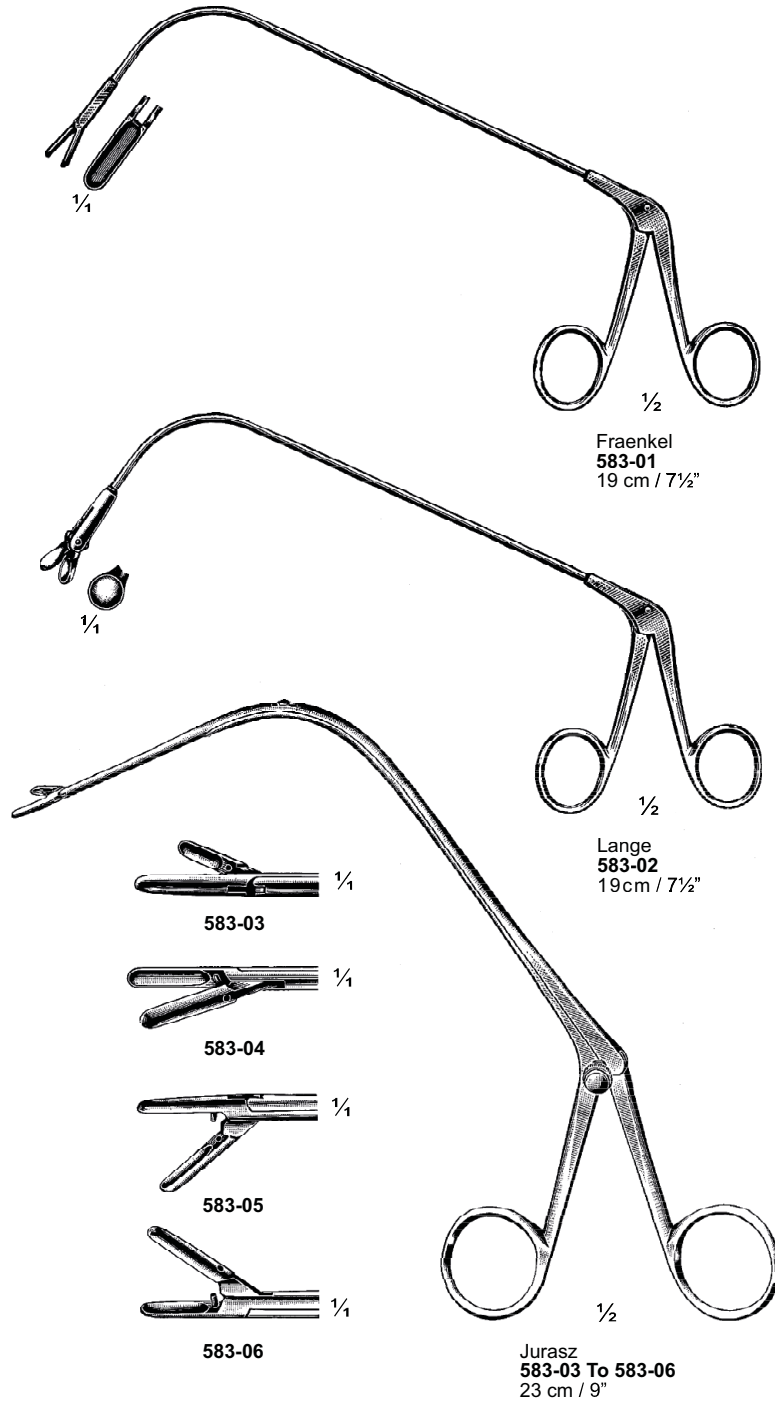

PINÇA PARA MAXILAR

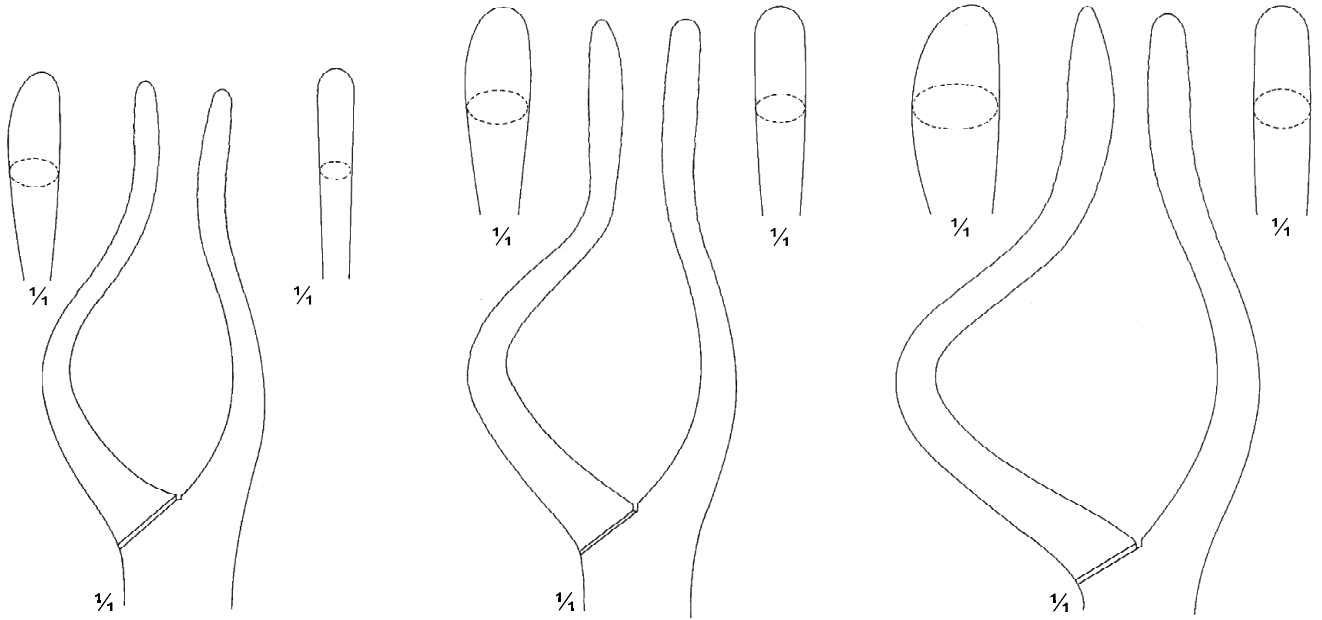

585-01
585-04

585-02
585-05

585-03
585-06



1/2

Rowe
585-01 To 585-03
23 cm / 9"
Left



1/2

Rowe
585-04 To 585-06
23 cm / 9"
Right

PINÇAS DE APREENSÃO E CURATIVO

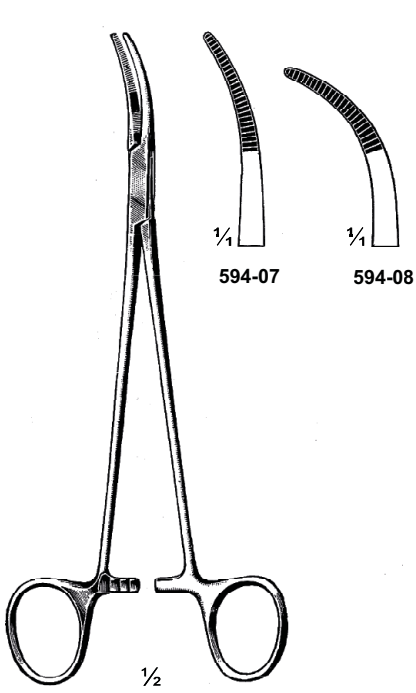

Schnidt
594-07 & 594-08
19cm / 7 1/2"

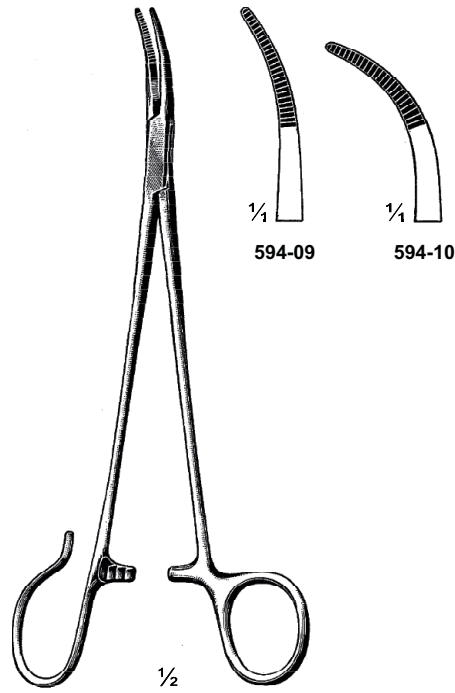

Schnidt
594-09 & 594-10
19cm / 7 1/2"

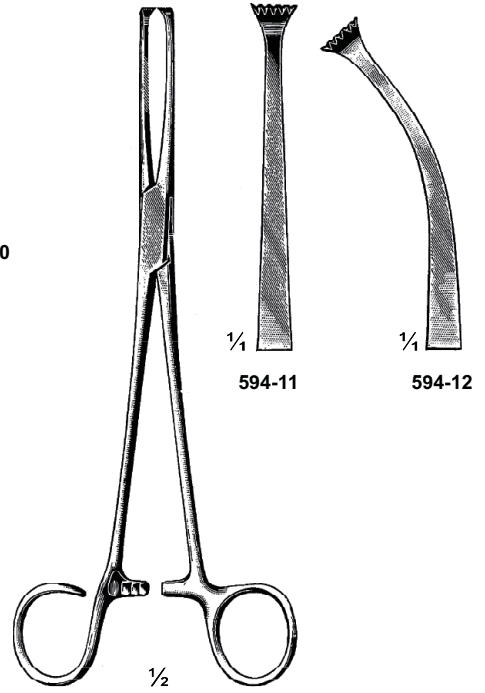

Colver
594-11 & 594-12
19 cm / 7 1/2"

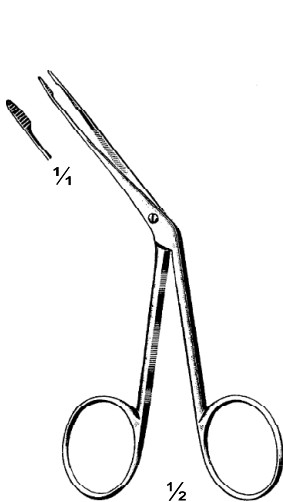

Hartmann
672-02
13 cm / 5 1/8"

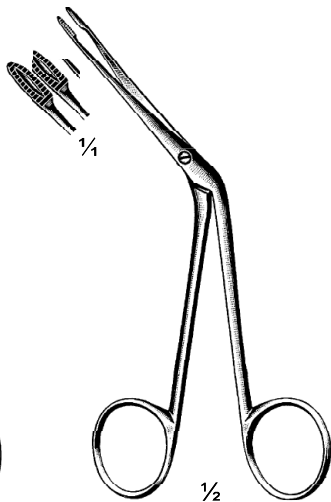

Hartmann
672-03
14 cm / 5 1/2"

PINÇA PARA RETIRADA DE PÓLIPOS

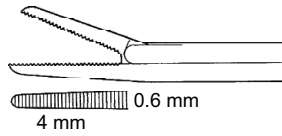

674-07 0.6 X 4 mm
Str, Serr

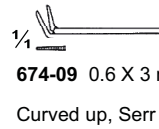

674-09 0.6 X 3 mm
Curved up, Serr

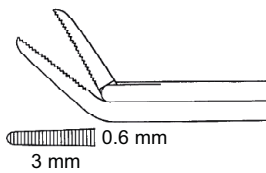

674-11 0.6 X 3 mm
Right, Serr

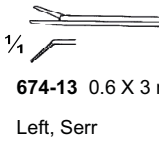

674-13 0.6 X 3 mm
Left, Serr



674-07 To 674-13
Shaft 8 cm / 3 1/8"

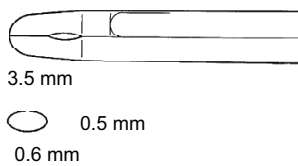

676-05
Str



676-06
Curved up



676-05 To 676-08
Shaft 8 cm / 3 1/8"
Oval cup 0.5 X 0.6 mm
Jaw length 3.5 mm



676-07
Right



676-08
Left

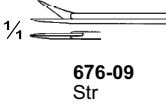
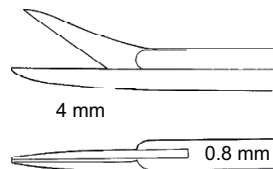

676-09
Str

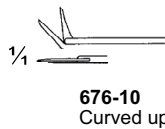

676-10
Curved up



Bellucci
676-09 To 676-12
Shaft 8 cm / 3 1/8"
Blade length 4 mm
Very delicate



676-11
Right



676-12
Left

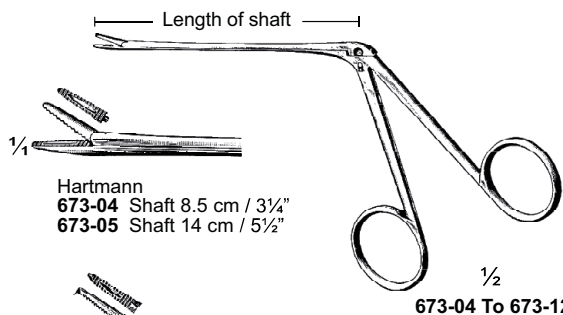

Hartmann
673-04 Shaft 8.5 cm / 3 1/4"
673-05 Shaft 14 cm / 5 1/2"

673-04 To 673-12



Hartmann
673-11 Shaft 8.5 cm / 3 1/4"
673-12 Shaft 14 cm / 5 1/2"
1 X 2 Teeth

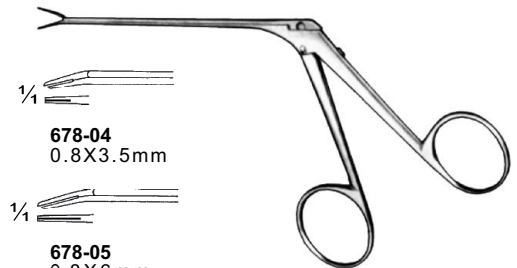

678-04
0.8 X 3.5 mm

678-05
0.8 X 6 mm

McGee
678-04 & 678-05
Shaft 8 cm / 3 1/8"

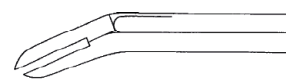

PINÇAS NASAIS

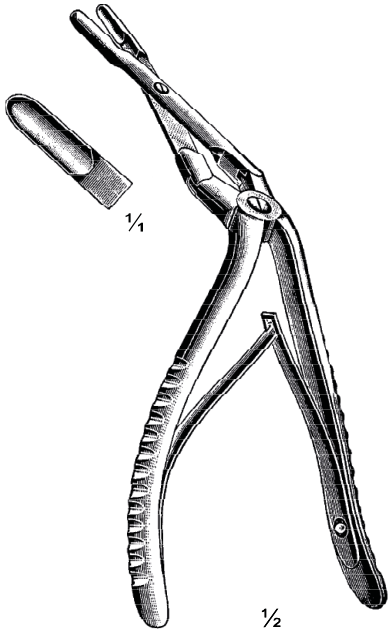

Middleton-Jansen
623-01
19 cm / 7½"

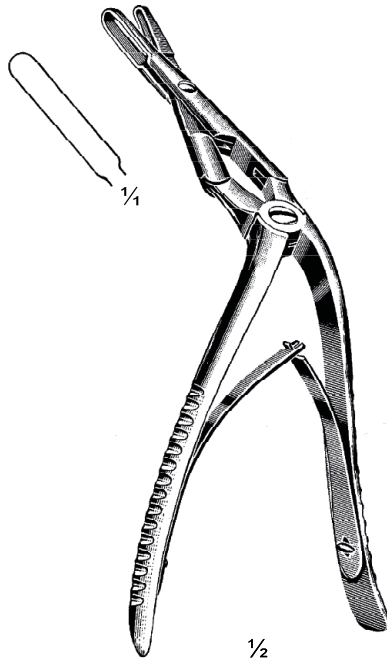

Middleton-Jansen
623-02
19 cm / 7½"

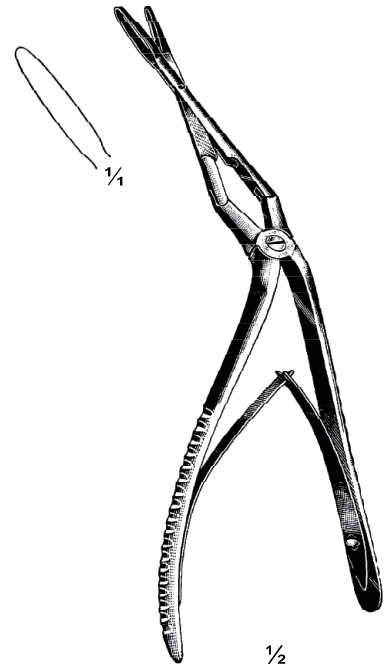

Middleton-Struycken
623-03
19 cm / 7½"

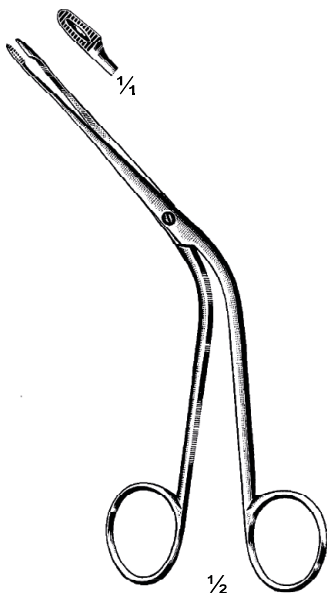

Hartmann
619-01
16 cm / 6¼"

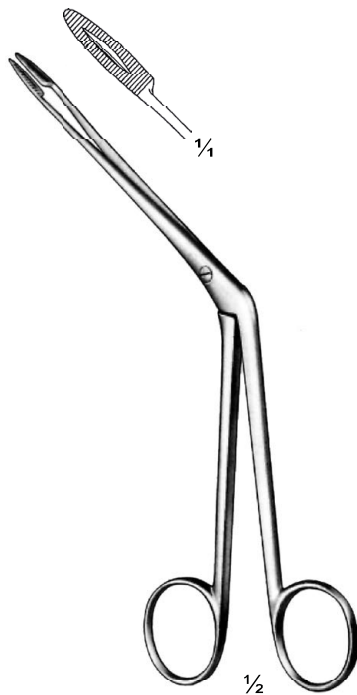

Hartmann
619-02
20 cm / 8"

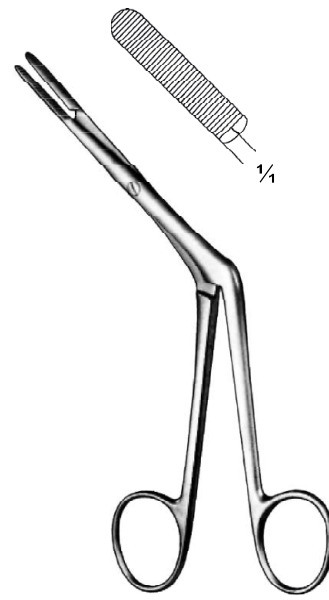

Killian
619-09
17 cm / 6¾"

PINÇAS NASAIS

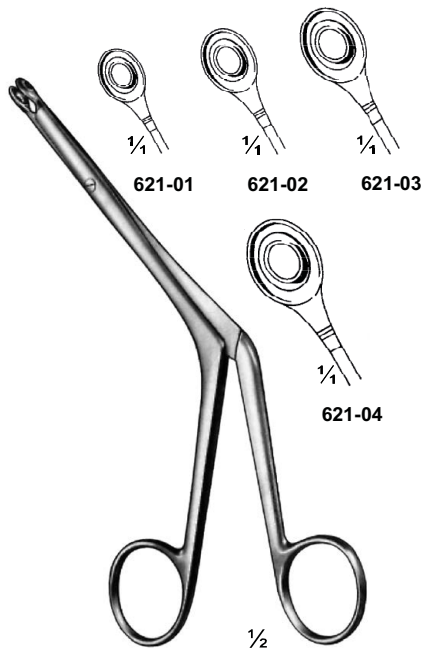

Bruenings
621-01 To 621-04
19 cm / 7½"

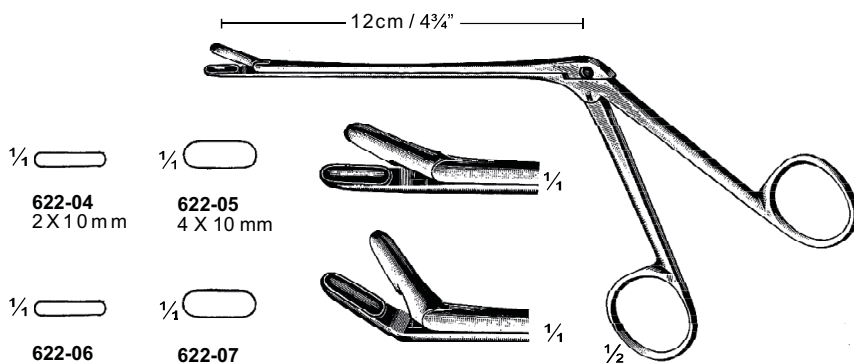

Takahashi
622-04 To 623-07
19 cm / 7½"

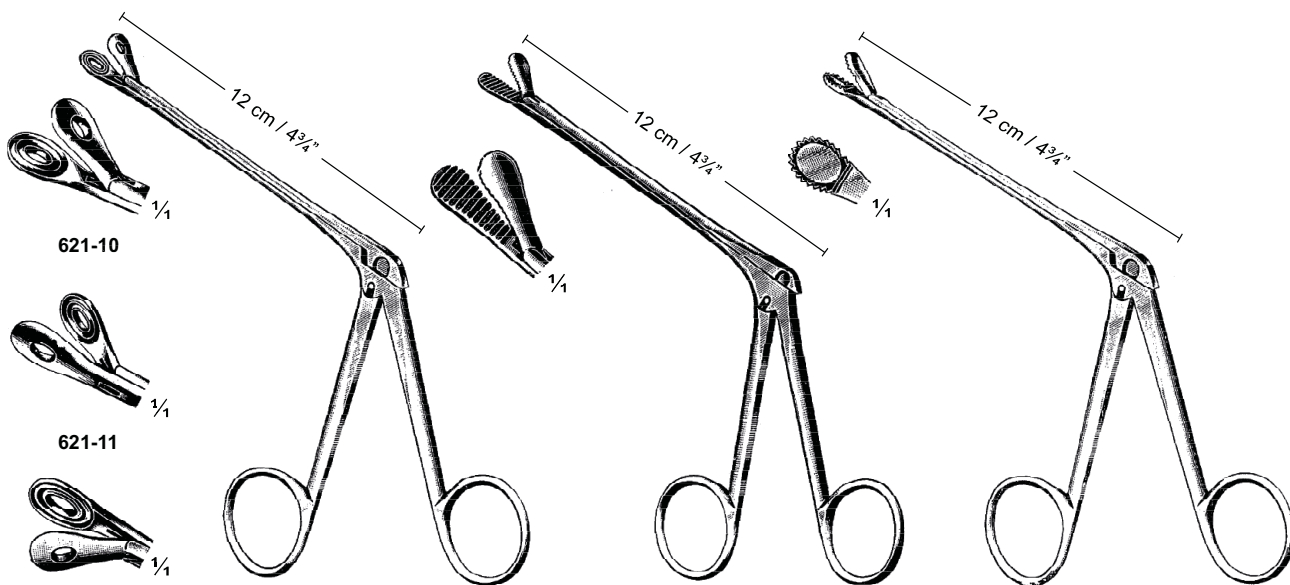

Blakesley (Lewis)
621-10 To 621-12
Shaft 12 cm / 4¾"

Blakesley
621-13
Shaft 12 cm / 4¾"

Blakesley
621-14
Shaft 12 cm / 4¾"

PINÇAS PARA RINOPLASTIA

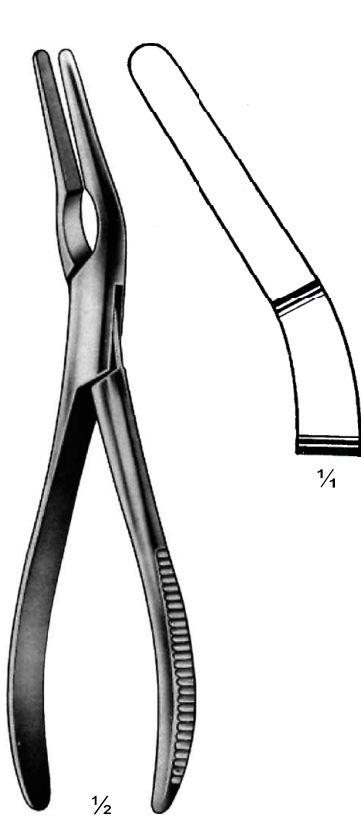

Asch
642-03
22 cm / 8 3/4"



643-02
Right



Walsham
643-02 & 643-03
23 cm / 9"



643-03
Left

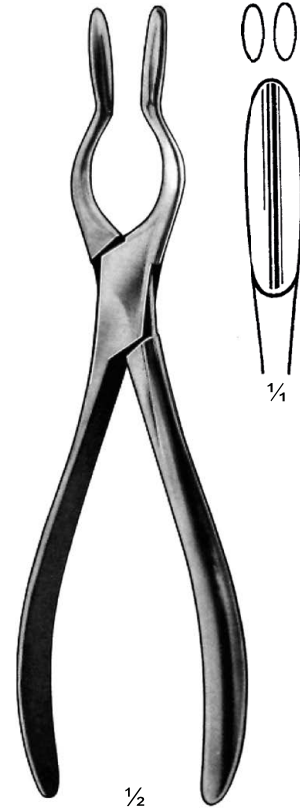

Walsham (Universal)
643-04
23 cm / 9"

PINÇAS PARA LAMINECTOMIA

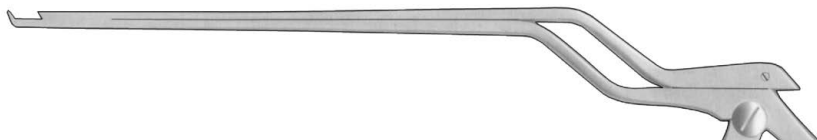

Kerrison
654-02 To 654-16
 Shaft 18-20-23 cm
 Bayonet shaft

18-20-23 cm

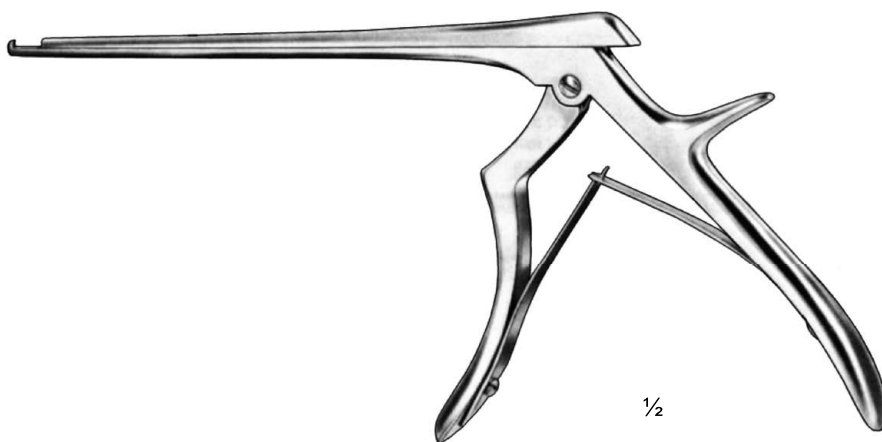

$\frac{1}{2}$
 Kerrison
654-19 To 654-33
 Shaft 18-20-23 cm

$\frac{1}{4}$ □		654-02 654-19 1 X 2 mm
$\frac{1}{4}$ □		654-04 654-21 2 X 2 mm
$\frac{1}{4}$ □		654-05 654-22 3 X 3 mm
$\frac{1}{4}$ □		654-06 654-23 4 X 3 mm
$\frac{1}{4}$ □		654-08 654-25 5 X 3 mm

$\frac{1}{4}$ □		654-12 654-29 1 X 2 mm
$\frac{1}{4}$ □		654-13 654-30 2 X 3 mm
$\frac{1}{4}$ □		654-14 654-31 3 X 4 mm
$\frac{1}{4}$ □		654-15 654-32 4 X 4 mm
$\frac{1}{4}$ □		654-16 654-33 5 X 5 mm

PINÇAS PARA LAMINECTOMIA

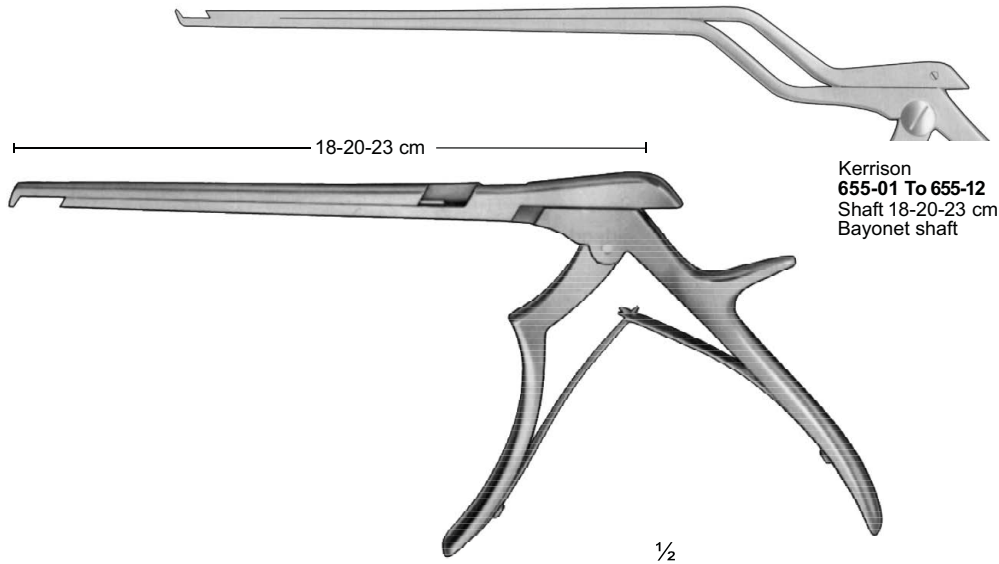

Kerrison
655-01 To 655-12
 Shaft 18-20-23 cm
 Bayonet shaft

Kerrison
655-14 To 655-25
 Shaft 18-20-23 cm

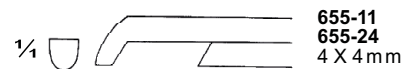
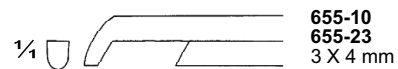
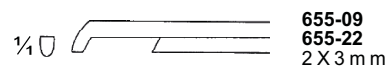
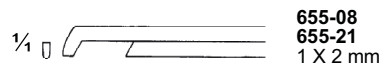
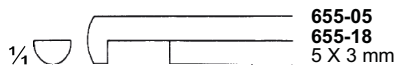
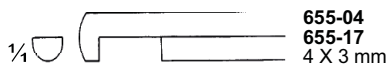
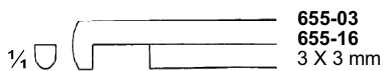
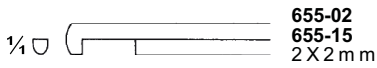

PINÇAS PARA LAMINECTOMIA

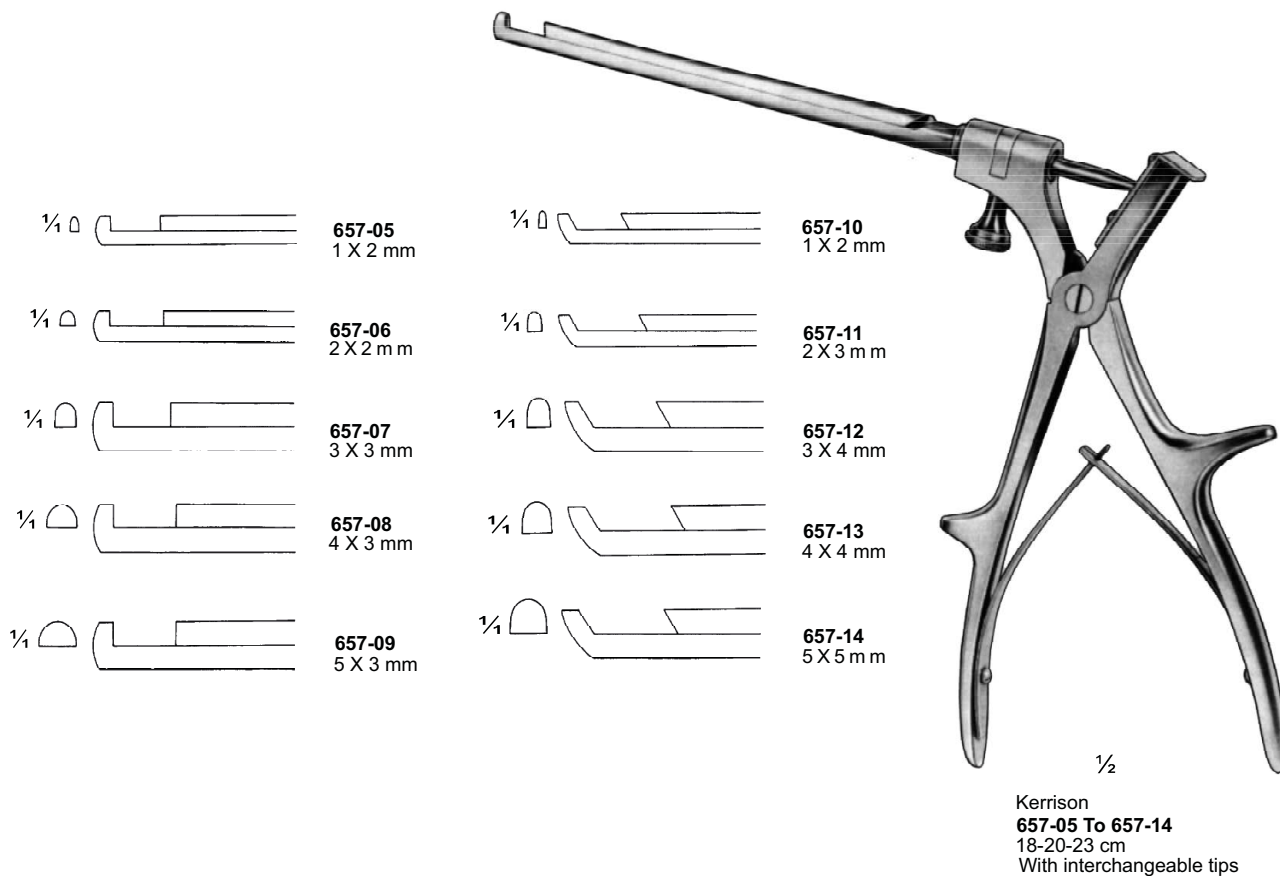
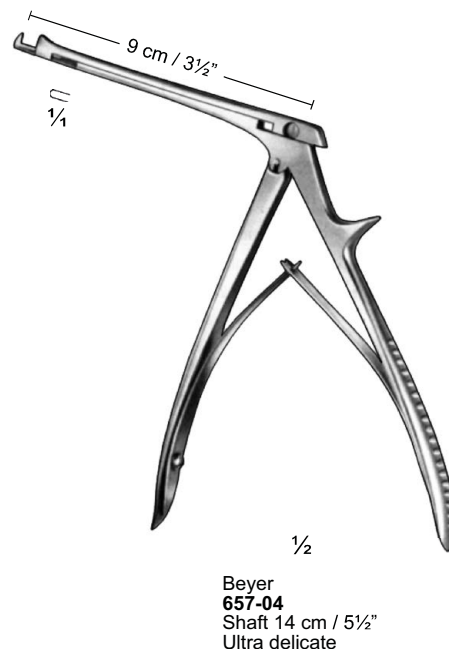
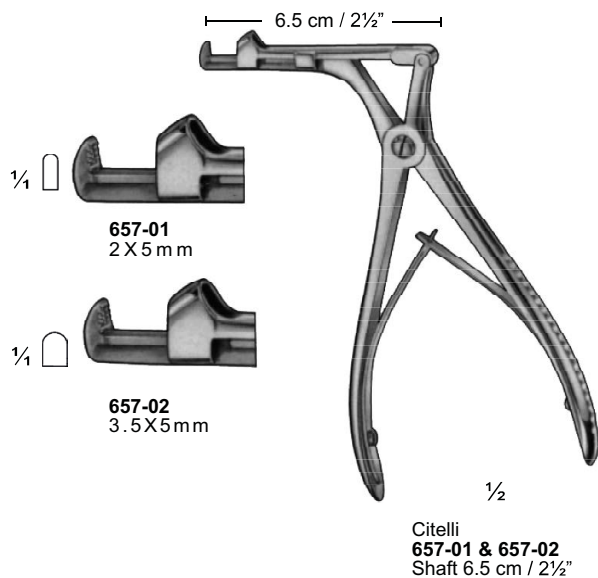

PINÇAS PARA LAMINECTOMIA

18 cm / 7"

1/4

Cushing
663-11 Shaft 12 cm / 4 3/4"
663-12 Shaft 15 cm / 6"
663-13 Shaft 18 cm / 7"
 2 X 10 mm

1/4

Cushing
663-14 Shaft 12 cm / 4 3/4"
663-15 Shaft 15 cm / 6"
663-16 Shaft 18 cm / 7"
 2 X 10 mm

1/4

Cushing
663-17 Shaft 12 cm / 4 3/4"
663-18 Shaft 15 cm / 6"
663-19 Shaft 18 cm / 7"
 2 X 10 mm

1/2

663-11 To 663-37

1/4

Love-Gruenwald
663-20 Shaft 12 cm / 4 3/4"
663-21 Shaft 15 cm / 6"
663-22 Shaft 18 cm / 7"
 3 X 10 mm

1/4

Love-Gruenwald
663-23 Shaft 12 cm / 4 3/4"
663-24 Shaft 15 cm / 6"
663-25 Shaft 18 cm / 7"
 3 X 10 mm

1/4

Love-Gruenwald
663-26 Shaft 12 cm / 4 3/4"
663-27 Shaft 15 cm / 6"
663-28 Shaft 18 cm / 7"
 3 X 10 mm

1/4

Spurling
663-29 Shaft 12 cm / 4 3/4"
663-30 Shaft 15 cm / 6"
663-31 Shaft 18 cm / 7"
 4 X 10 mm

1/4

Spurling
663-32 Shaft 12 cm / 4 3/4"
663-33 Shaft 15 cm / 6"
663-34 Shaft 18 cm / 7"
 4 X 10 mm

1/4

Spurling
663-35 Shaft 12 cm / 4 3/4"
663-36 Shaft 15 cm / 6"
663-37 Shaft 18 cm / 7"
 4 X 10 mm

15 cm / 6"

1/4

662-05 2 X 10 mm

662-06 3 X 10 mm

662-07 4 X 10 mm

1/4

662-08 2 X 10 mm

662-09 3 X 10 mm

662-10 4 X 10 mm

1/4

662-11 5 X 10 mm

662-12 6 X 10 mm

1/4

662-13 2 X 10 mm

662-14 3 X 10 mm

662-15 4 X 10 mm

1/2

Ferris-Smith-Cushing
662-05 To 662-15
 Shaft 17 cm / 7"

PINÇAS PARA LAMINECTOMIA

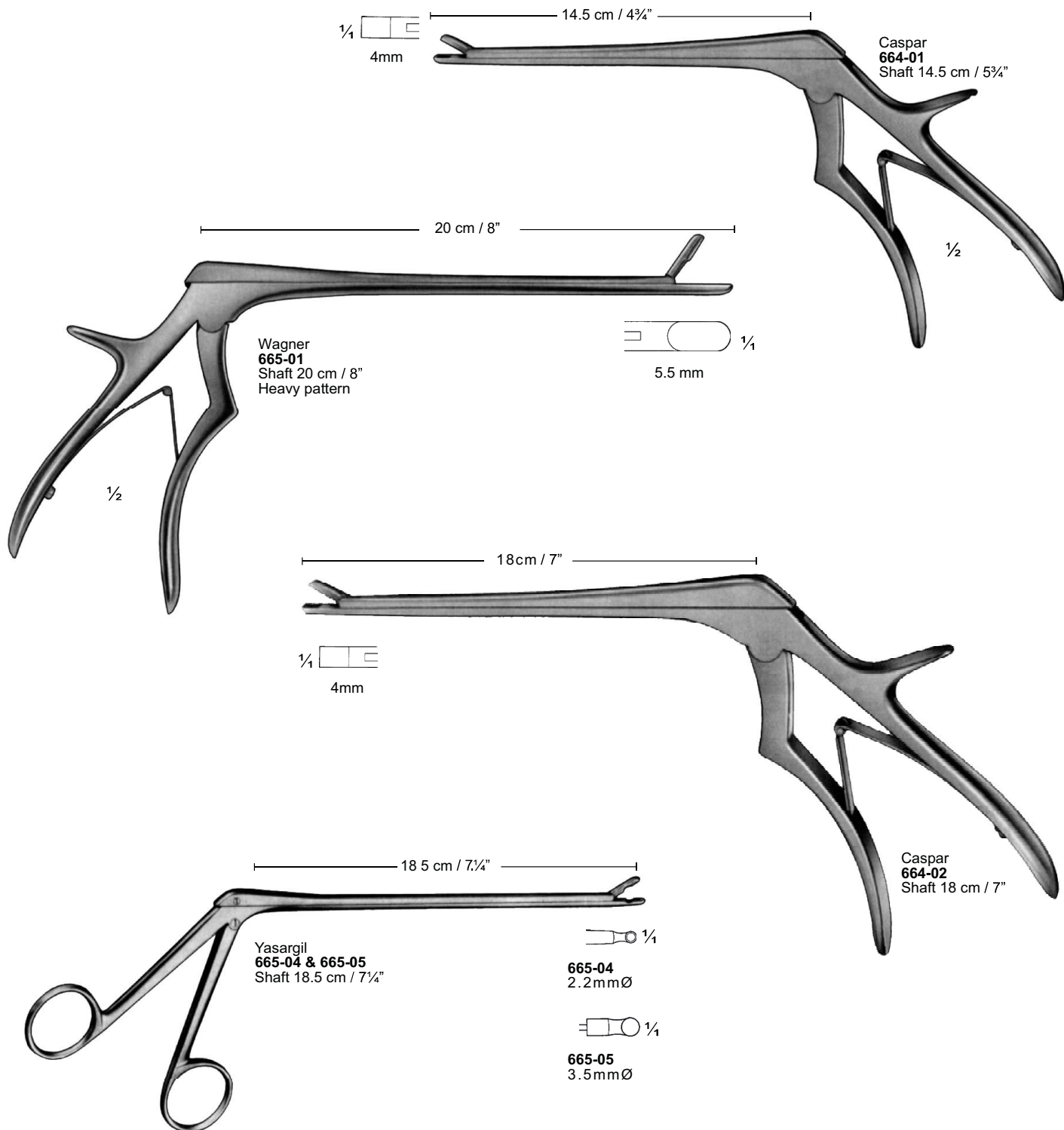

PINÇAS PARA OFTALMOLOGIA

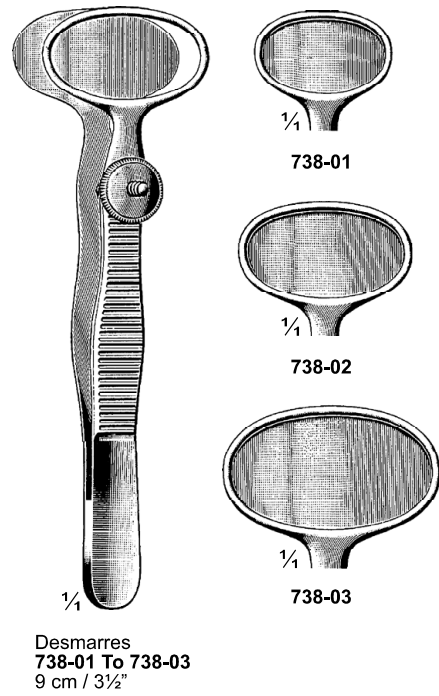
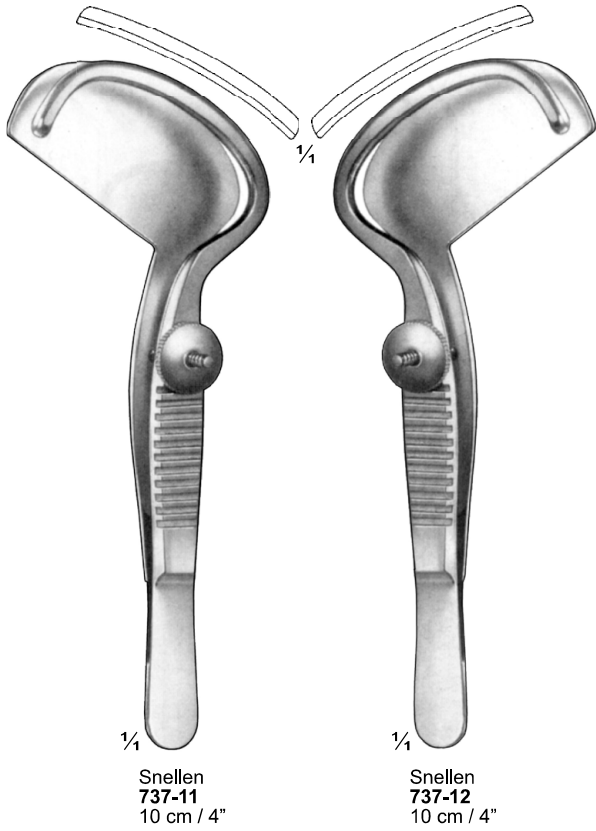

PINÇA PARA NEUROCIRURGIA

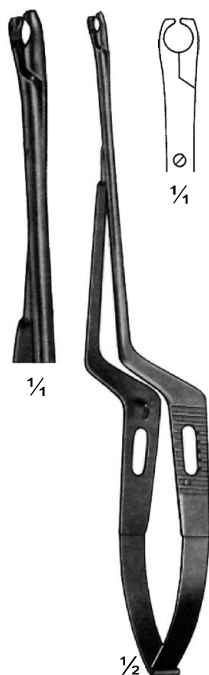

753-08 18 cm / 7"
753-09 22 cm / 8 3/4"

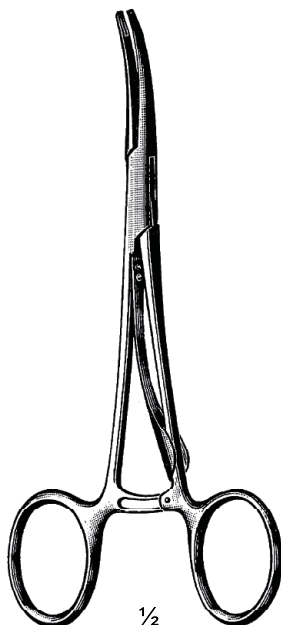

McKenzie
754-01 15 cm / 6"
754-02 18 cm / 7"

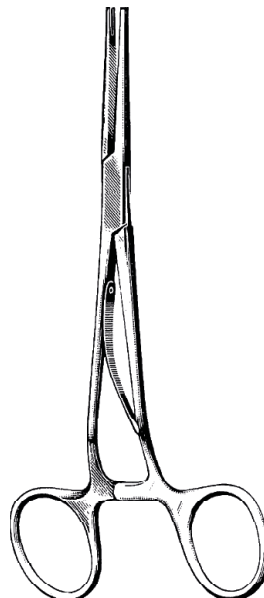

McKenzie
754-03 15 cm / 6"
754-04 18 cm / 7"



Raney
754-06
16 cm / 6 1/4"



Yasargil
753-20
25mm



Yasargil
753-21
75 mm

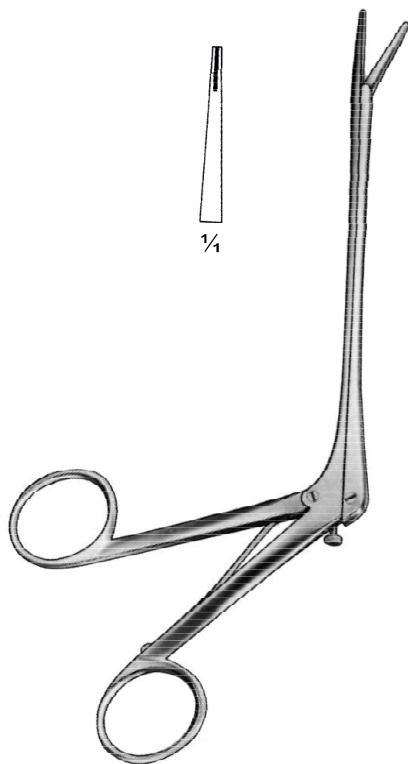

Olivecrona-Toennis
(Scoville)
754-07
Shaft length 14 cm / 5 1/2"

PINÇAS DE APREENSÃO

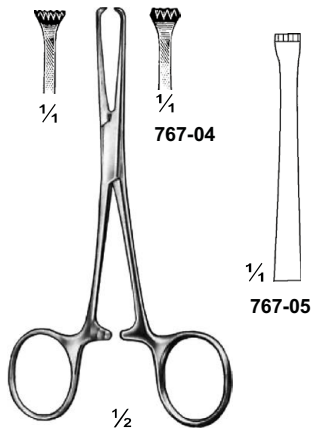

Allis-Baby
767-04 12 cm / 4³/₄"
767-05 13 cm / 5¹/₈"
 4 X 5 Teeth

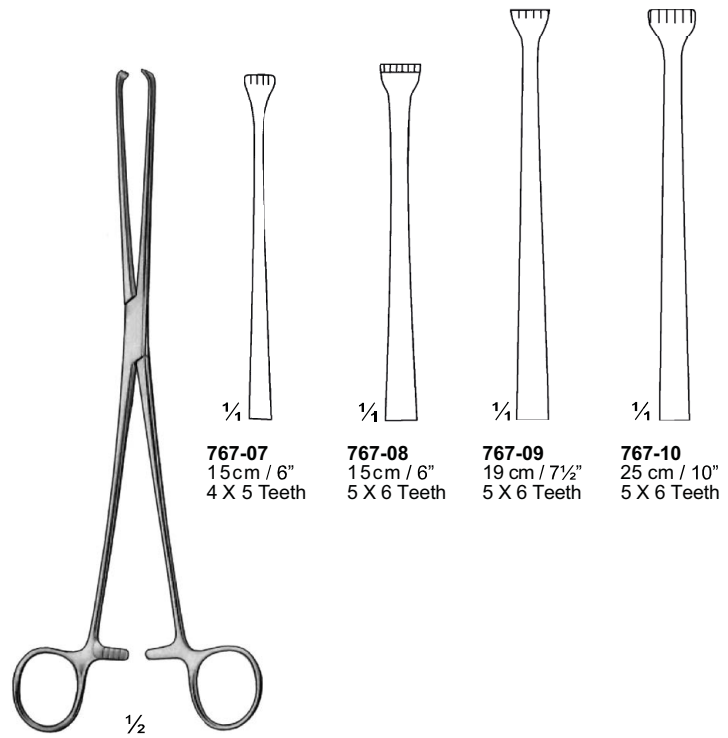

767-07
 15 cm / 6"
 4 X 5 Teeth

767-08
 15 cm / 6"
 5 X 6 Teeth

767-09
 19 cm / 7¹/₂"
 5 X 6 Teeth

767-10
 25 cm / 10"
 5 X 6 Teeth

Allis
767-07 To 767-10

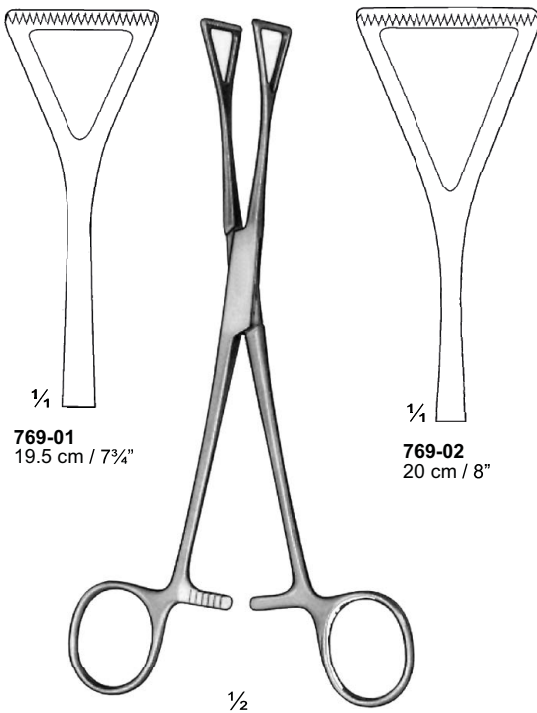

769-01
 19.5 cm / 7³/₄"

769-02
 20 cm / 8"

Duval-Collin
769-01 & 769-02

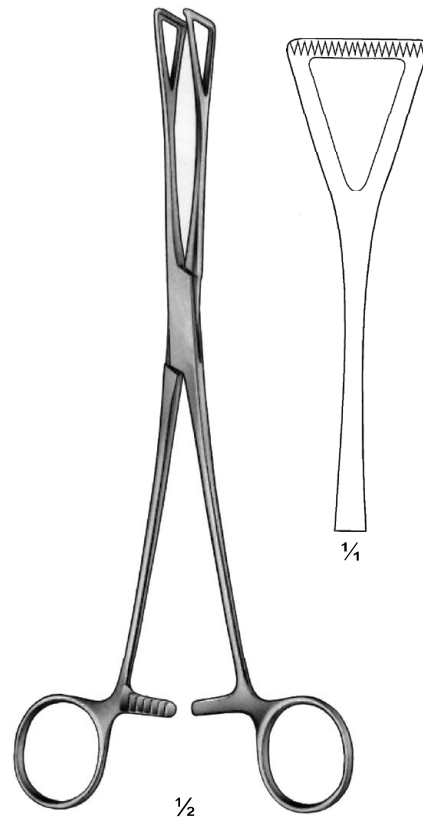

Duval
769-03
 23 cm / 9"

PINÇAS DE APREENSÃO

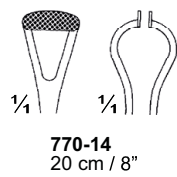
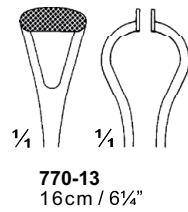
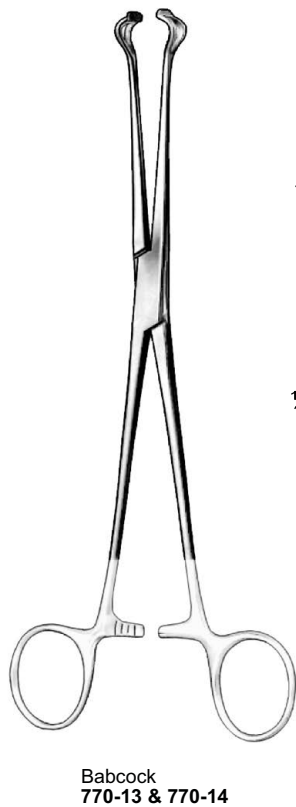
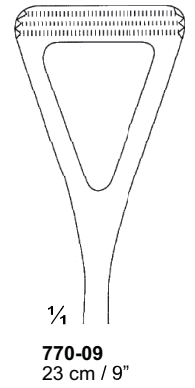
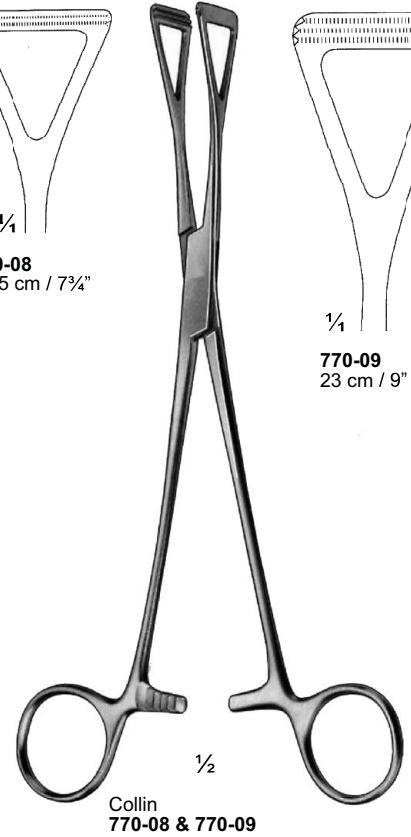
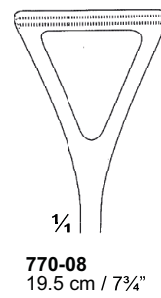
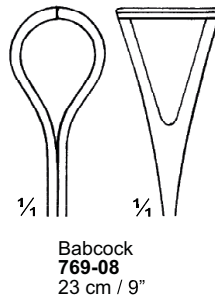
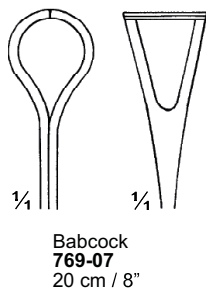
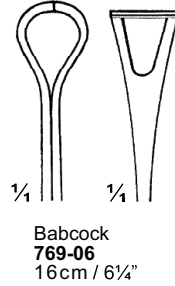
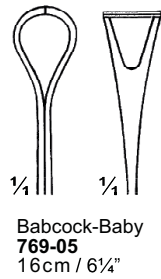

Item No. 770-13 To 770-15
With Tungsten Carbide
inserts

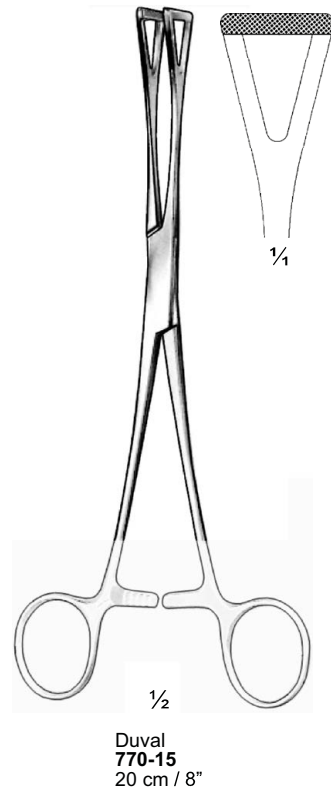

PINÇAS INTESTINAIS

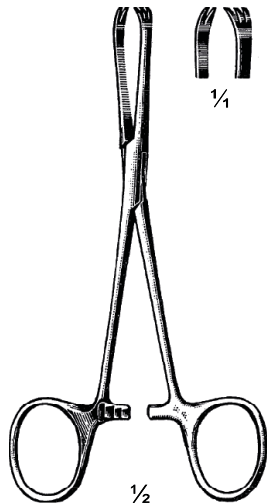

Chaput
179-01
14 cm / 5½"

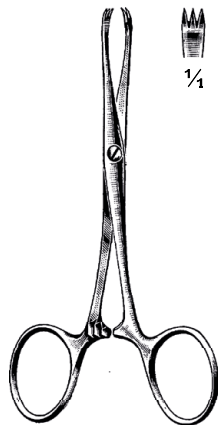

Chaput
179-02
13 cm / 5¼"

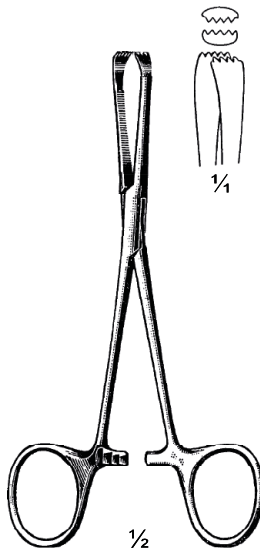

Tuffier
179-03
14 cm / 5½"

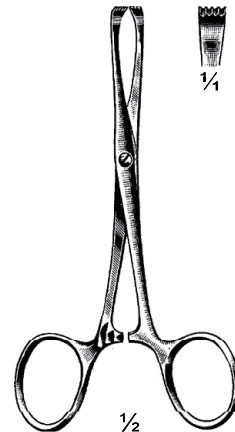

Tuffier
179-04
13 cm / 5¼"

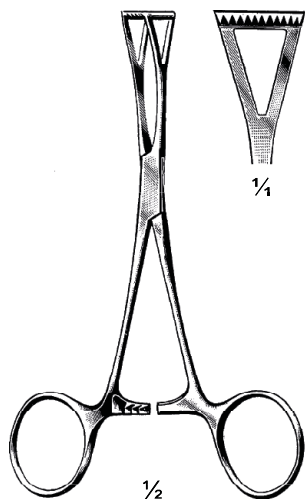

Collin
179-05
14 cm / 5½"

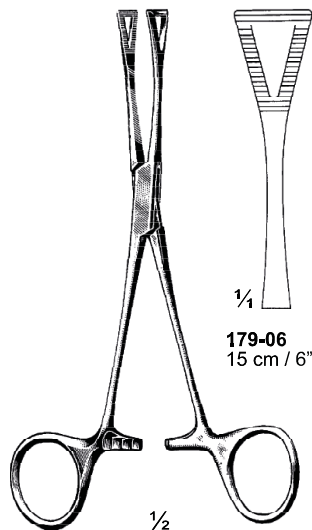

Pennington
179-06 & 179-07

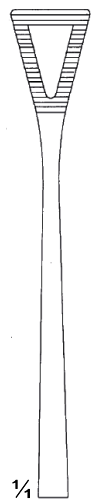

179-07
20 cm / 8"

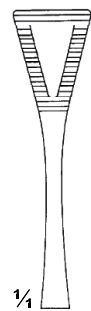

179-06
15 cm / 6"

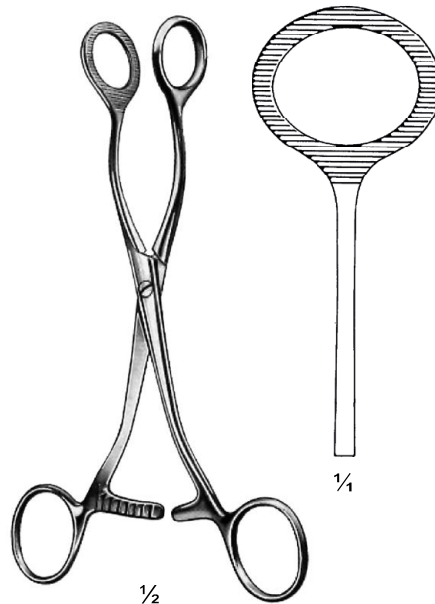

Collin
179-08
16.5 cm / 6½"

PINÇAS INTESTINAIS

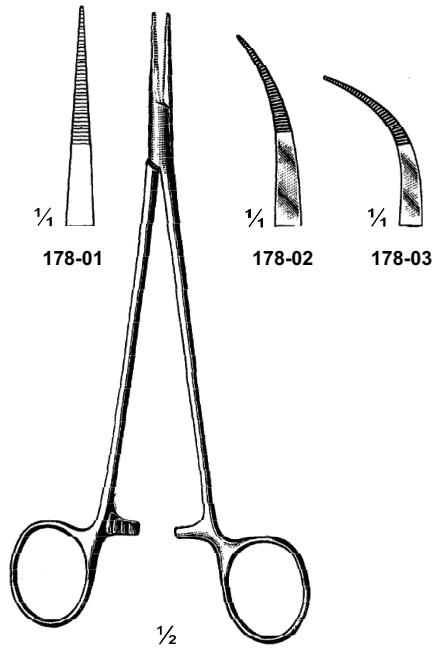

178-01

178-02

178-03

1/2

Jacobson-Micro
178-01 To 178-03
18 cm / 7"

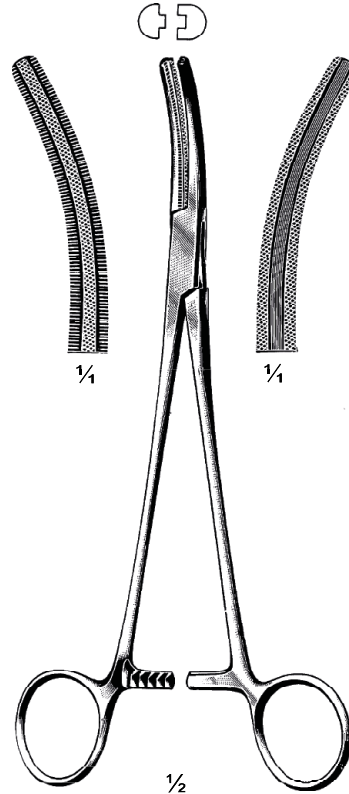

1/4

1/4

1/2

Buie
180-03
21 cm / 8 1/4"

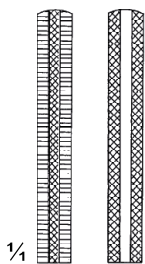

1/4

180-04
16 cm / 6 1/4"

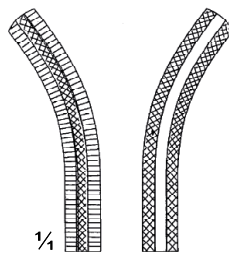

1/4

180-05
16 cm / 6 1/4"

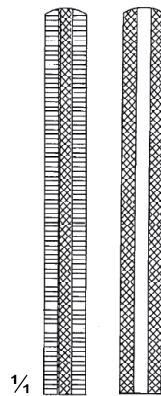

1/4

180-06
20 cm / 8"

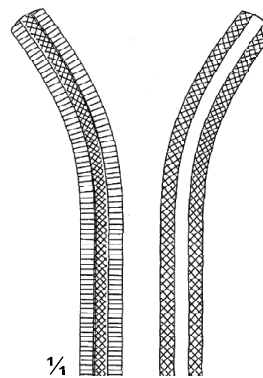

1/4

180-07
20 cm / 8"

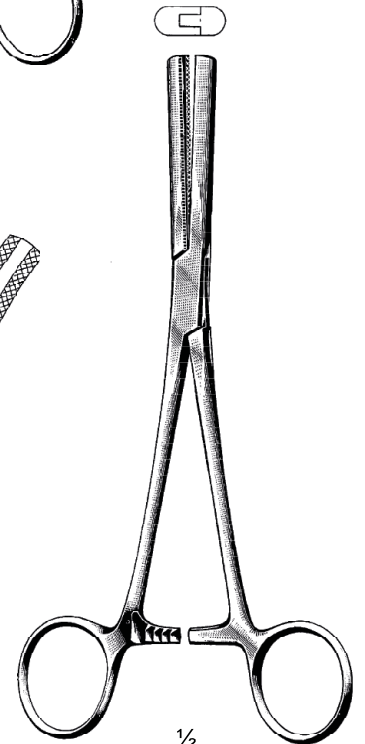

1/2

Fergusson
180-04 To 180-07

PINÇAS PARA INTESTINO



Doyen
772-06 To 772-09



772-06
16.5 cm / 6½"



772-07
18cm / 7"



772-08
16.5 cm / 6½"

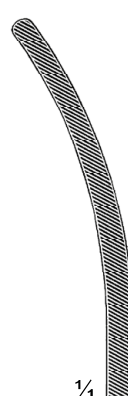

772-09
18cm / 7"

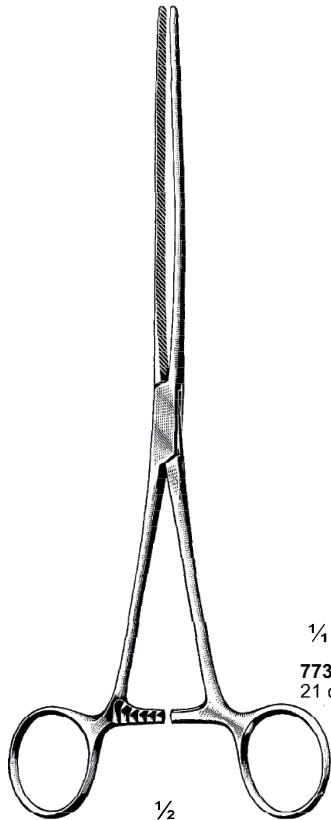

Doyen
773-01 To 773-06



773-01
21 cm / 8¼"

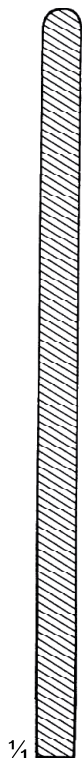

773-02 23 cm / 9"
773-03 25 cm / 10"

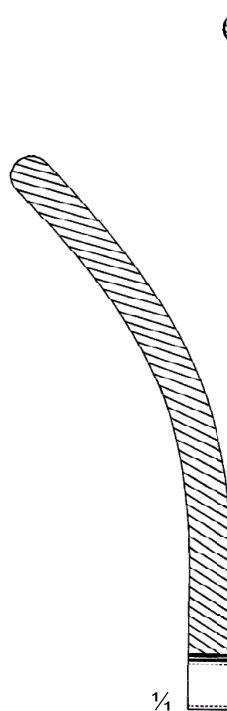

773-04
21 cm / 8¼"

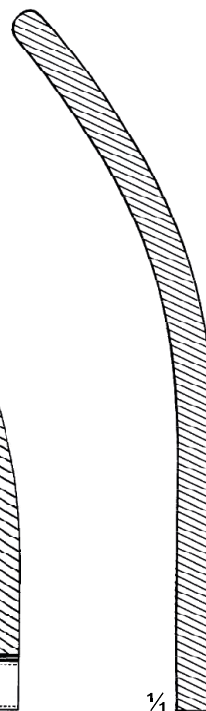

773-05 23 cm / 9"
773-06 25 cm / 10"

PINÇAS PARA INTESTINO

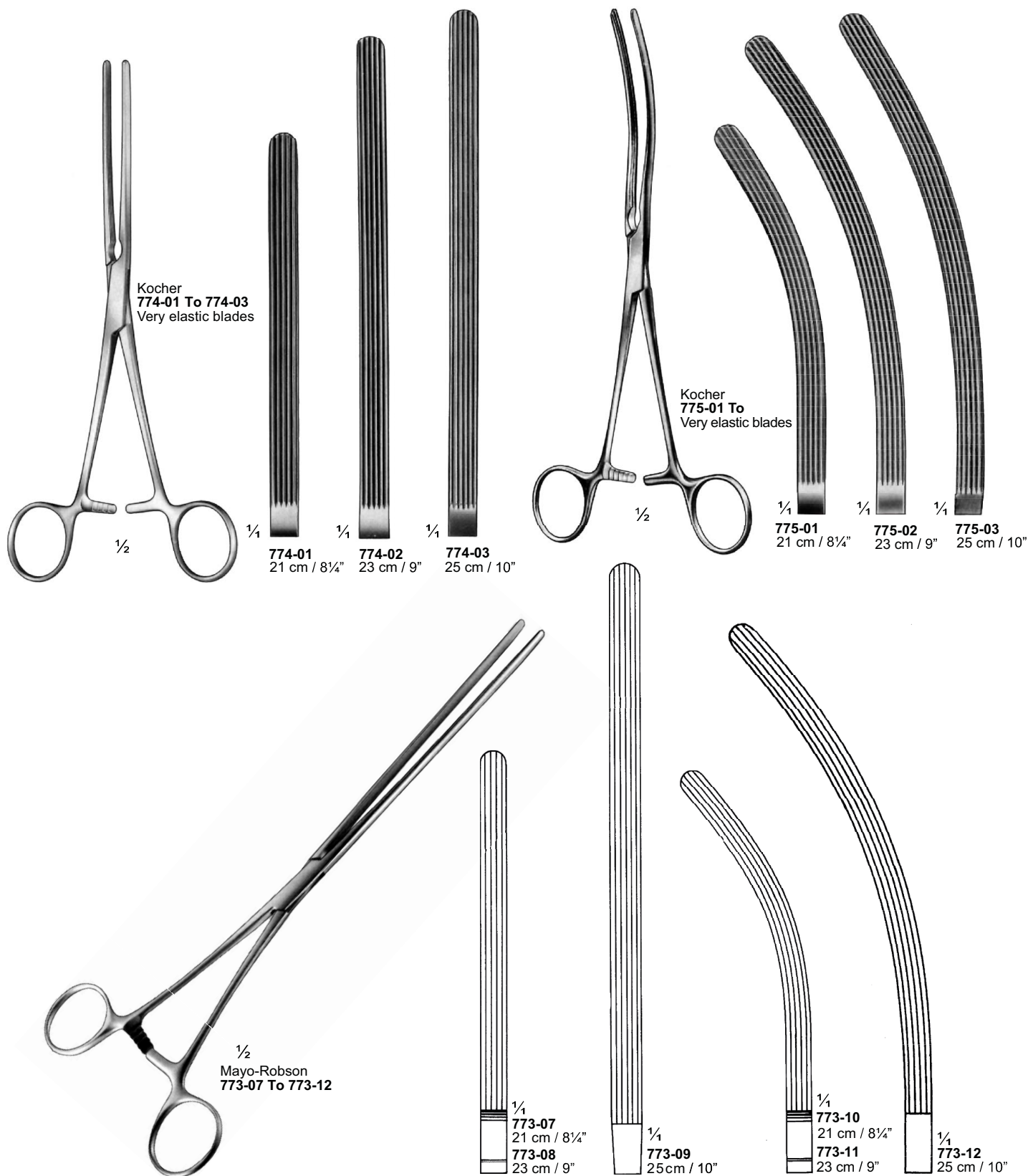

PINÇAS PARA INTESTINO E ESTOMAGO

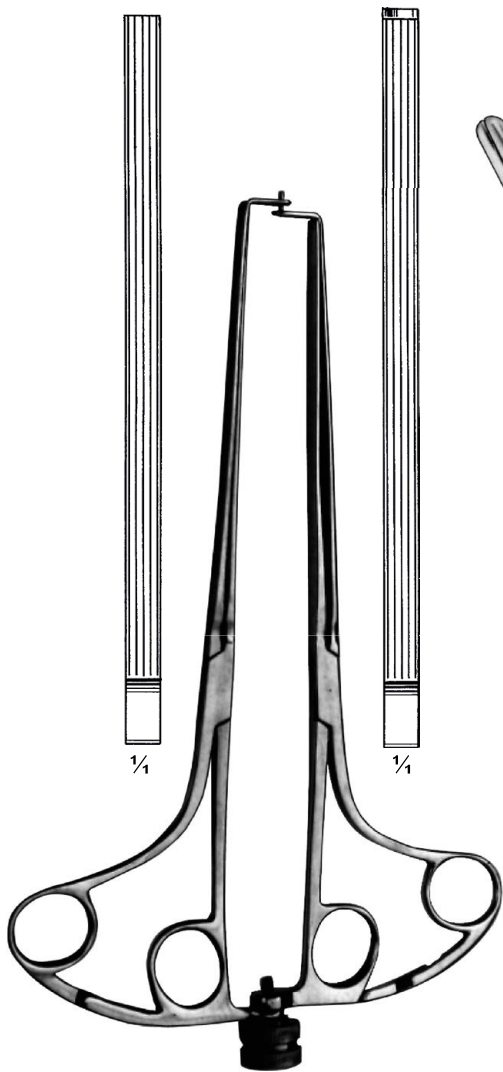

Abadie
783-03 22 cm / 8³/₄"
783-04 27 cm / 10¹/₂"



Payr
780-03 To 780-09

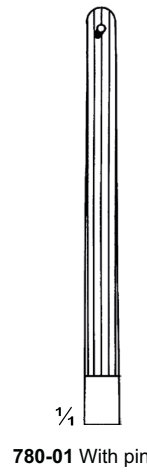

780-01 With pin

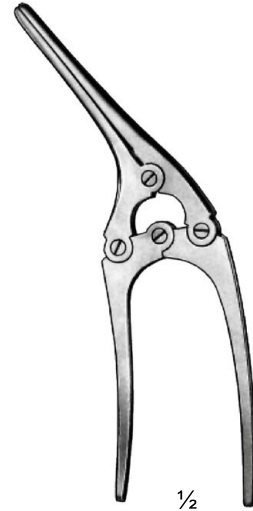

Payr-Baby
780-01
 15 cm / 6"

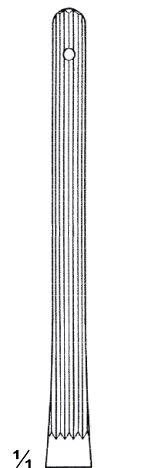

780-03 With pin
 18 cm / 7"

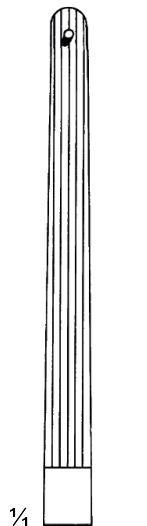

780-05 With pin
 21 cm / 8¹/₄"

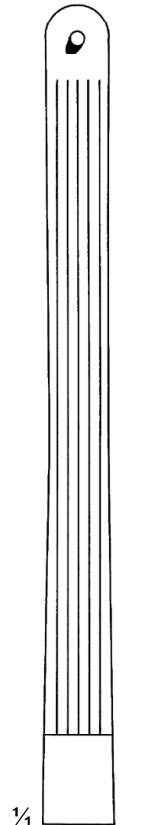

780-07 With pin
 29 cm / 11¹/₂"

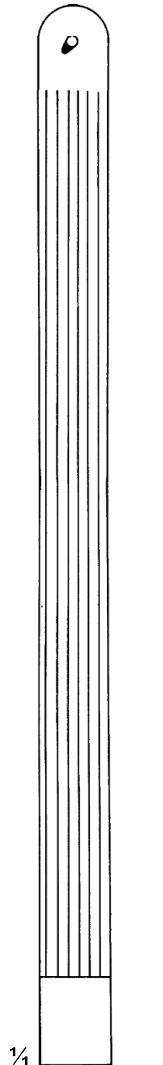

780-09 With pin
 35 cm / 13³/₄"

PINÇAS PARA INTESTINO E ESTOMAGO



Doyen
785-01 To 785-10

1/4

785-01
13cm / 5 1/8"

1/4

785-02
16cm / 6 1/4"

1/4

785-03
18cm / 7"

1/4

785-04
21 cm / 8 1/4"

1/4

785-05
23 cm / 9"

1/4

785-06
13cm / 5 1/8"

1/4

785-07
16cm / 6 1/4"

1/4

785-08
18 cm / 7"

1/4

785-09
21 cm / 8 1/4"

1/4

785-10
23 cm / 9"

PINÇAS PARA INTESTINO E ESTOMAGO

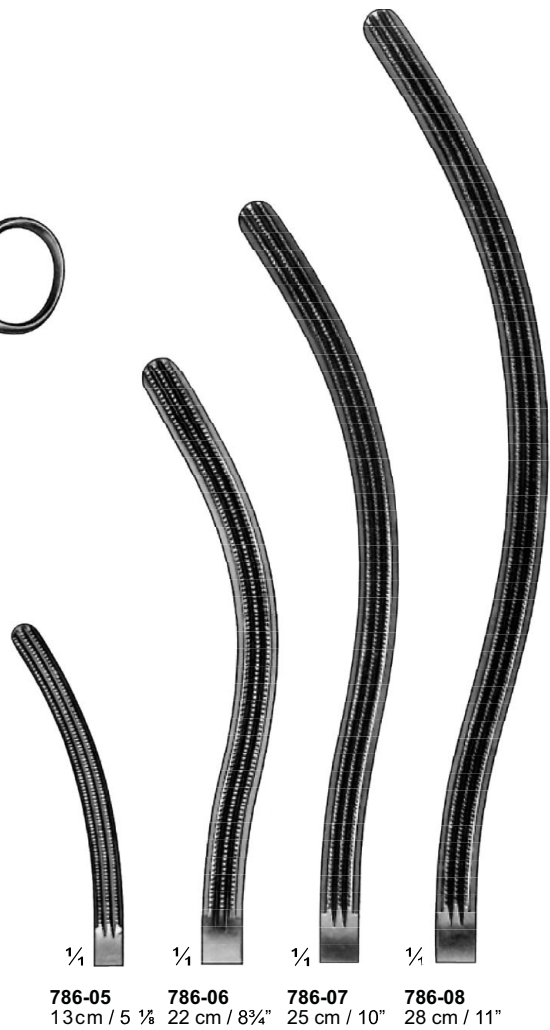
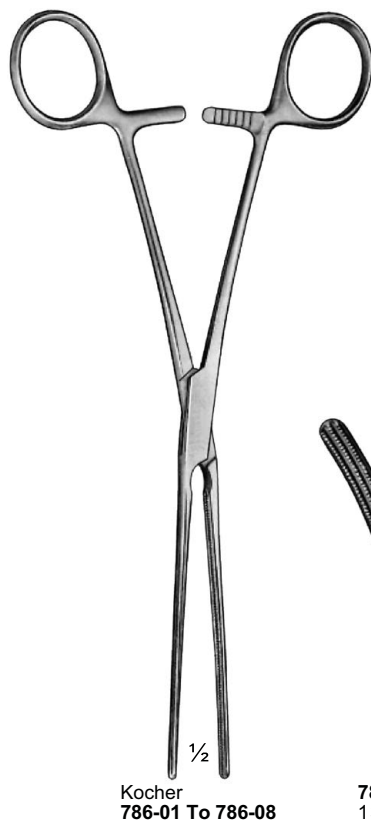
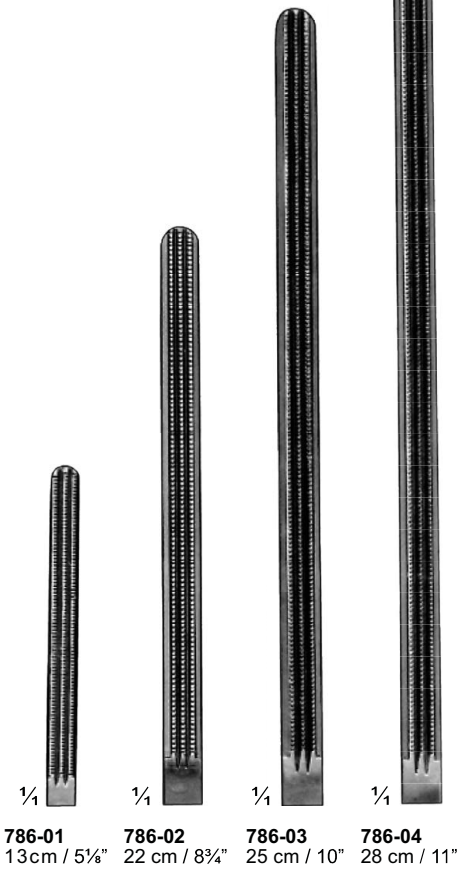
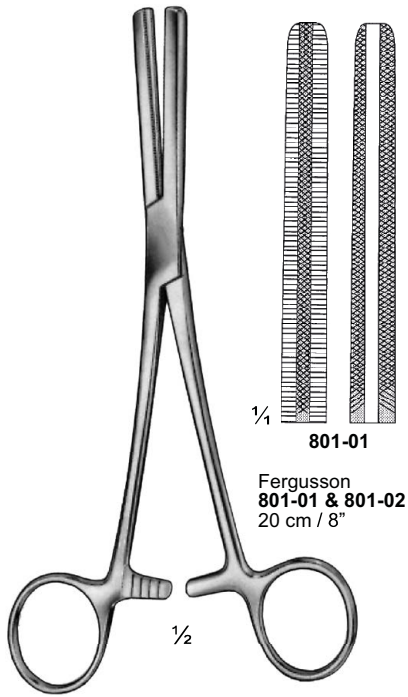

PINÇAS BULLDOG E PINÇAS ATRAUMÁTICAS



$\frac{1}{4}$
 Glover
808-04 7 cm / 2 $\frac{3}{4}$ "
808-05 8 cm / 3 $\frac{1}{8}$ "
808-06 9 cm / 3 $\frac{1}{2}$ "
808-07 11 cm / 4 $\frac{1}{4}$ "



$\frac{1}{4}$
 Glover
808-08 6.5 cm / 2 $\frac{1}{2}$ "
808-09 7.5 cm / 3"
808-10 8.5 cm / 3 $\frac{1}{4}$ "
808-11 10.5 cm / 4 $\frac{1}{8}$ "



Glover
808-12
 5 cm / 2"



$\frac{1}{2}$
 De Bakey-Mosquito
809-18 To 809-21



$\frac{1}{4}$
809-18
 12.5 cm / 5"



$\frac{1}{4}$
809-19
 12.5 cm / 5"



$\frac{1}{4}$
809-20
 15 cm / 6"



$\frac{1}{4}$
809-21
 15 cm / 6"

PINÇAS BULLDOG E PINÇAS ATRAUMÁTICAS



De Bakey-Satinsky
809-01
7 cm / 2¾"

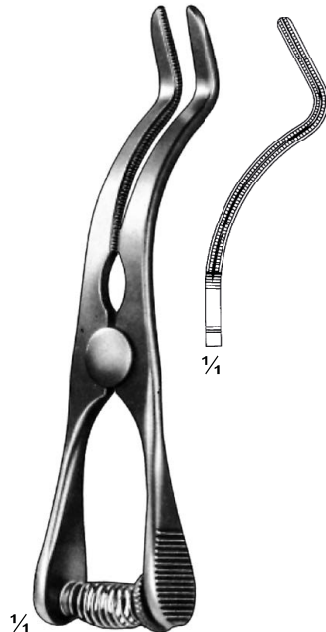

De Bakey-Carotis
809-02
9 cm / 3½"

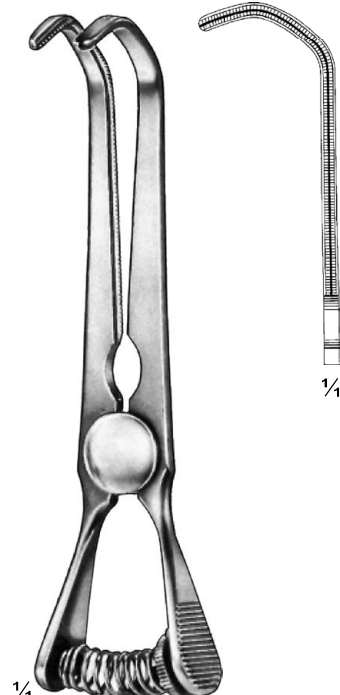

De Bakey-Satinsky
809-03
10 cm / 4"



De Bakey
809-04
5 cm / 2"



De Bakey
809-05
5 cm / 2"



De Bakey
809-06 7.5 cm / 3"
809-07 8.5 cm / 3¼"
809-08 10.5 cm / 4¼"
809-09 12 cm / 4¾"



De Bakey
809-10 7.5 cm / 3"
809-11 8.5 cm / 3¼"
809-12 10.5 cm / 4¼"
809-13 12 cm / 4¾"

PINÇAS ATRAUMÁTICAS CARDIOVASCULAR

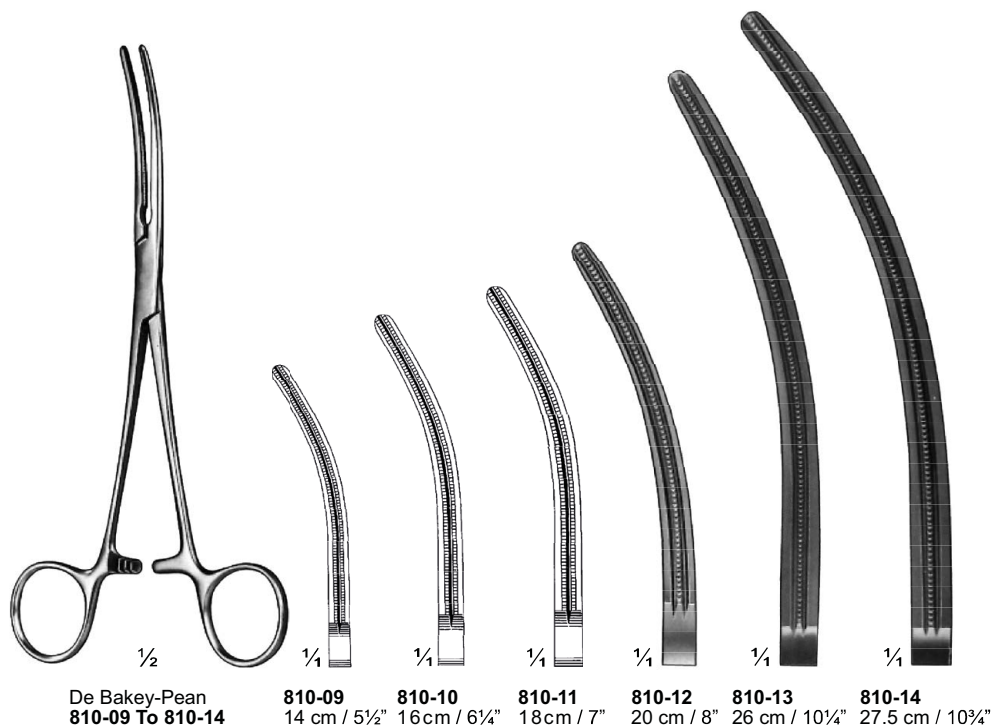
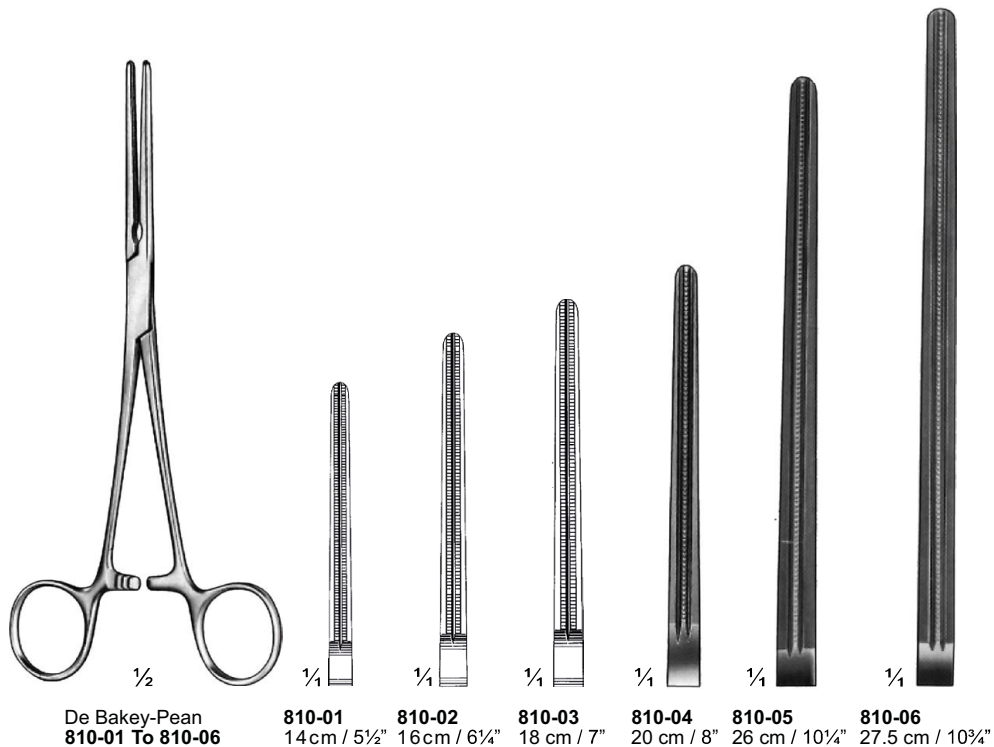

PINÇAS ATRAUMÁTICAS CARDIOVASCULAR

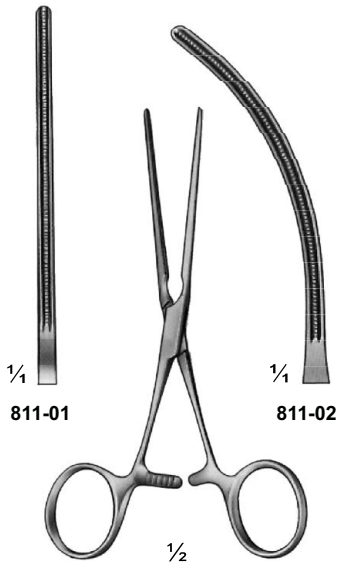

811-01 811-02

De Bakey
811-01 & 811-02
12.5 cm / 5"

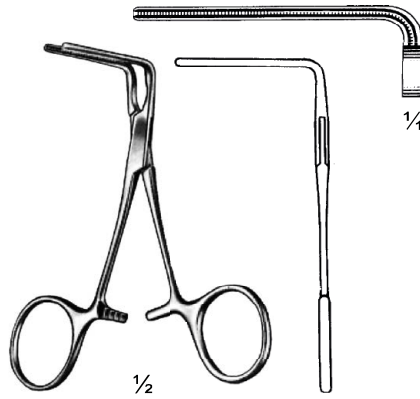

De Bakey
811-03
10cm / 4"

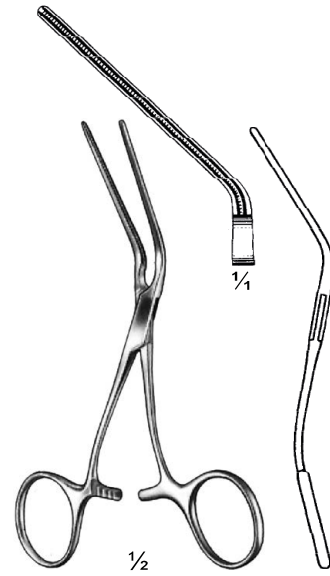

De Bakey
811-04
12.5 cm / 5"

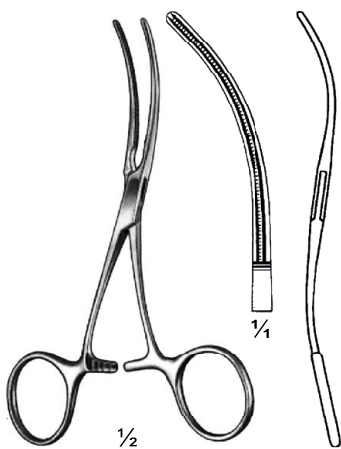

De Bakey
811-05
12 cm / 4 3/4"

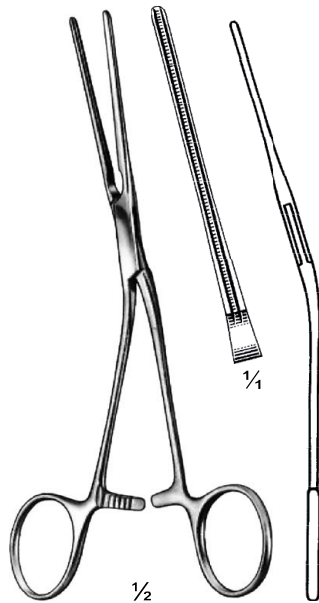

De Bakey
811-06
17 cm / 6 3/4"

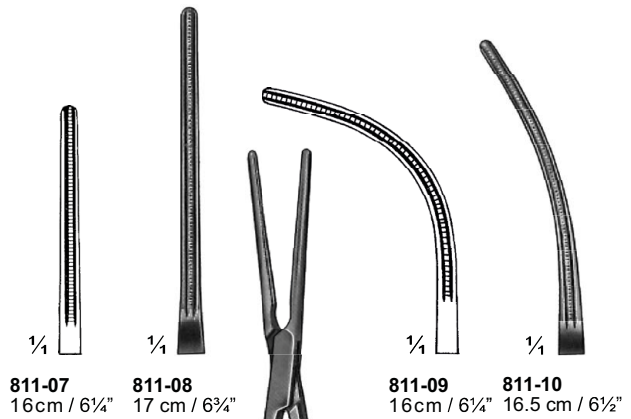

811-07 811-08
16cm / 6 1/4" 17 cm / 6 3/4"

811-09 811-10
16 cm / 6 1/4" 16.5 cm / 6 1/2"

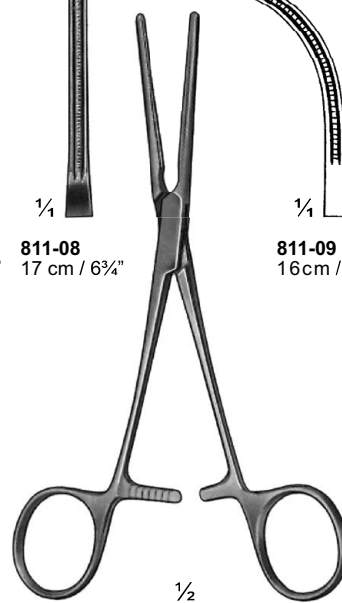

De Bakey
811-07 To 811-10

PINÇAS ATRAUMÁTICAS CARDIOVASCULAR

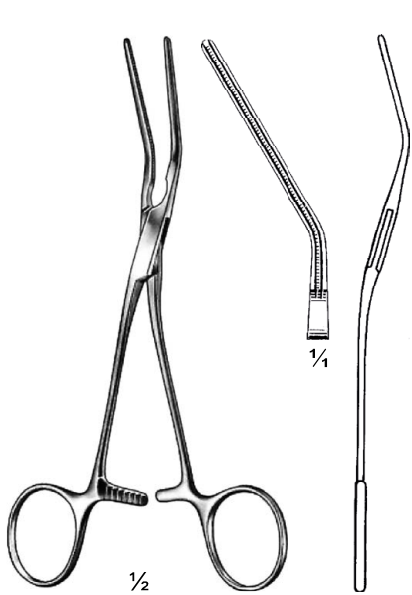

De Bakey
812-01
16cm / 6¼"

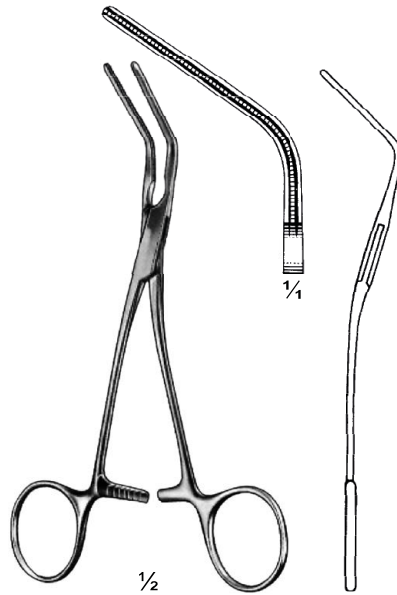

De Bakey
812-02
15 cm / 6"

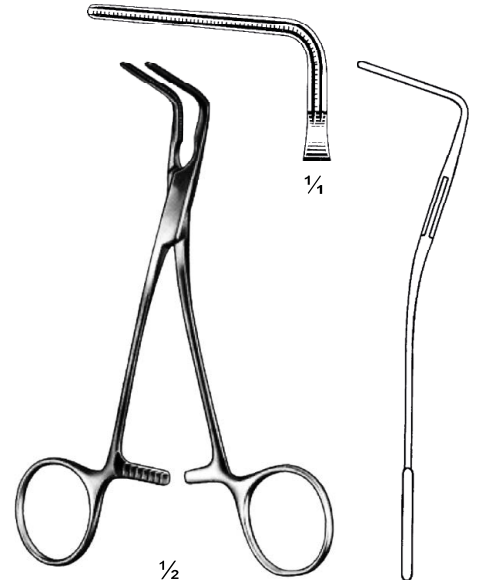

De Bakey
812-03
15 cm / 6"

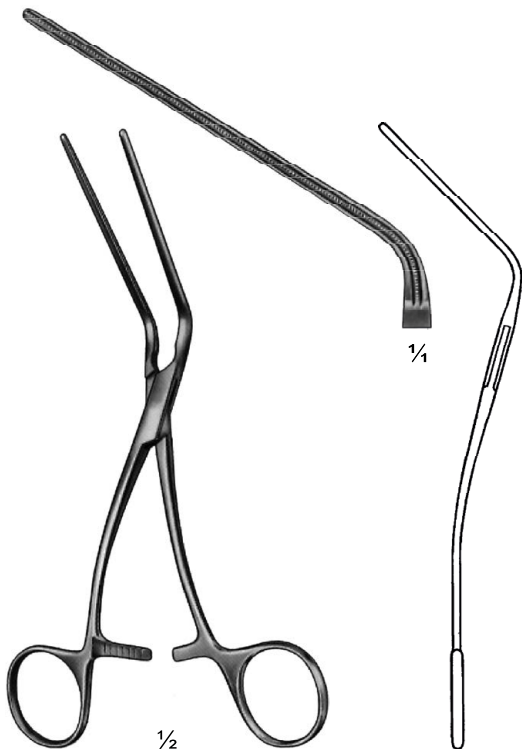

De Bakey
812-04
18cm / 7"

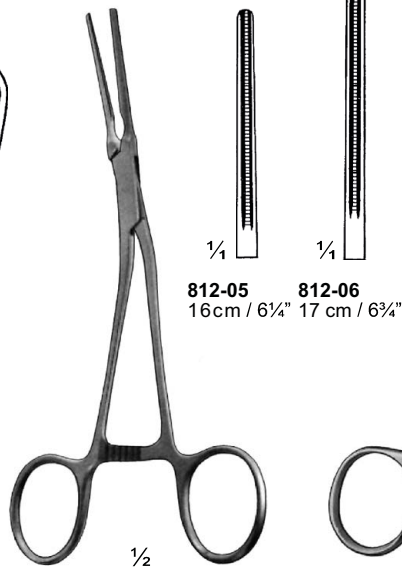

De Bakey
812-05 & 812-06

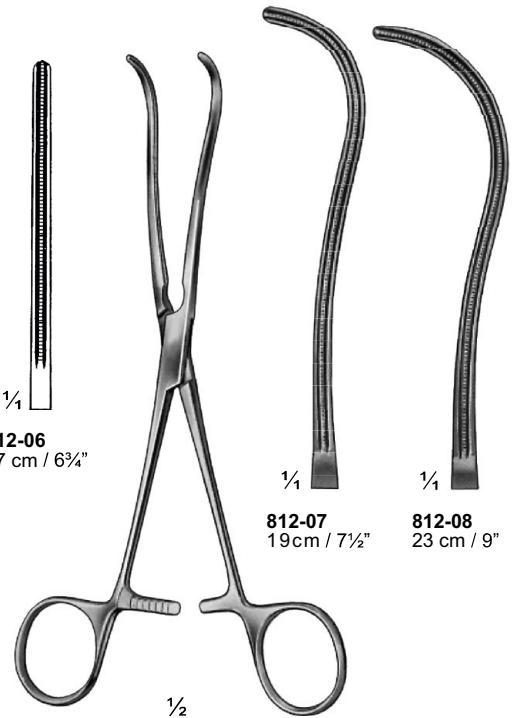

De Bakey
812-07 & 812-08

PINÇAS ATRAUMÁTICAS CARDIOVASCULAR

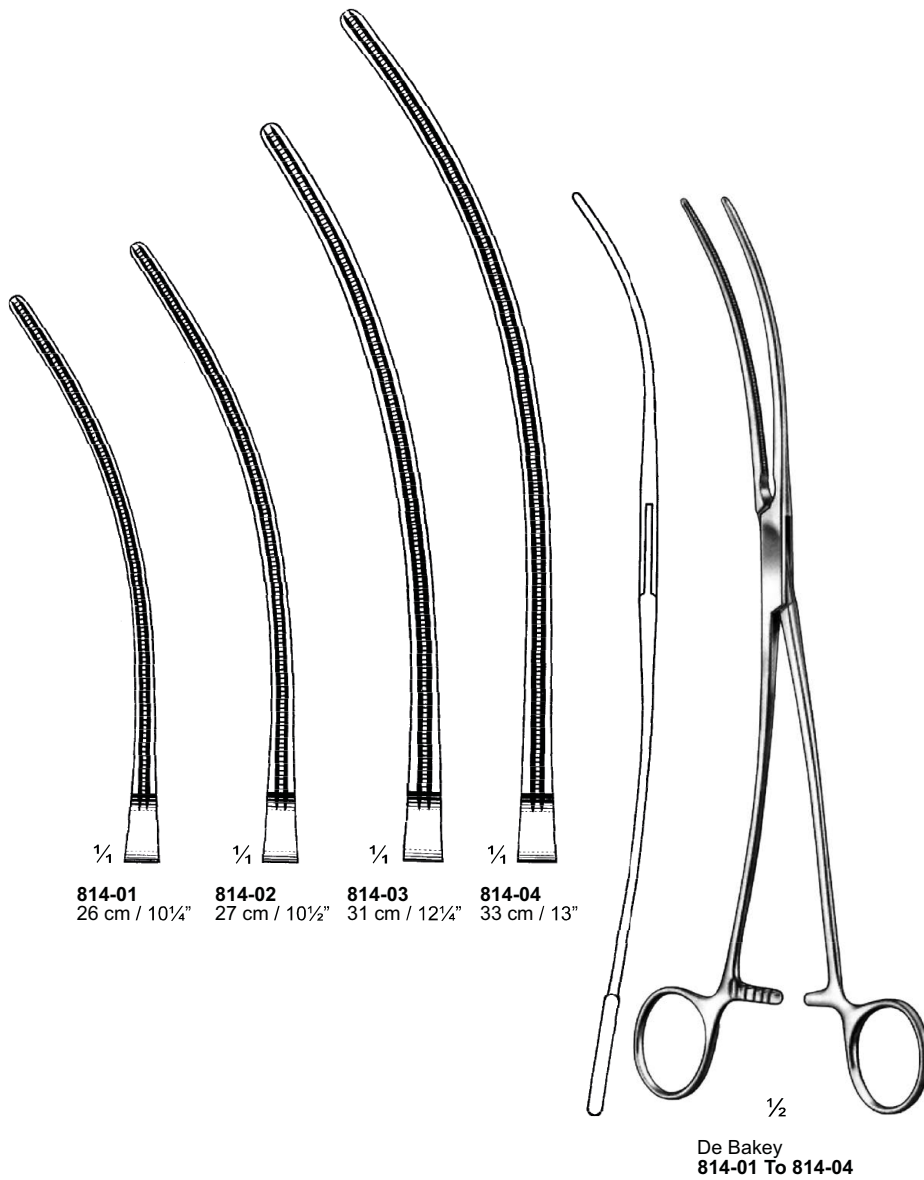

PINÇAS ATRAUMÁTICAS CARDIOVASCULAR

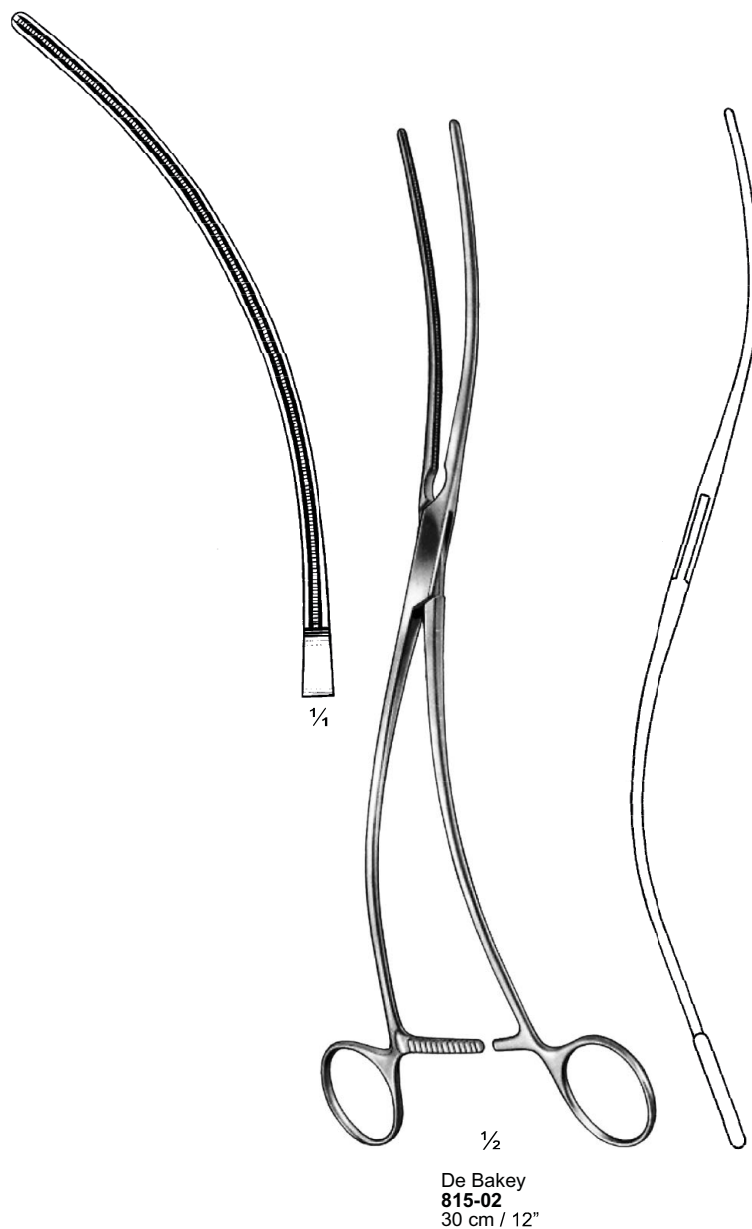

PINÇAS ATRAUMÁTICAS CARDIOVASCULAR

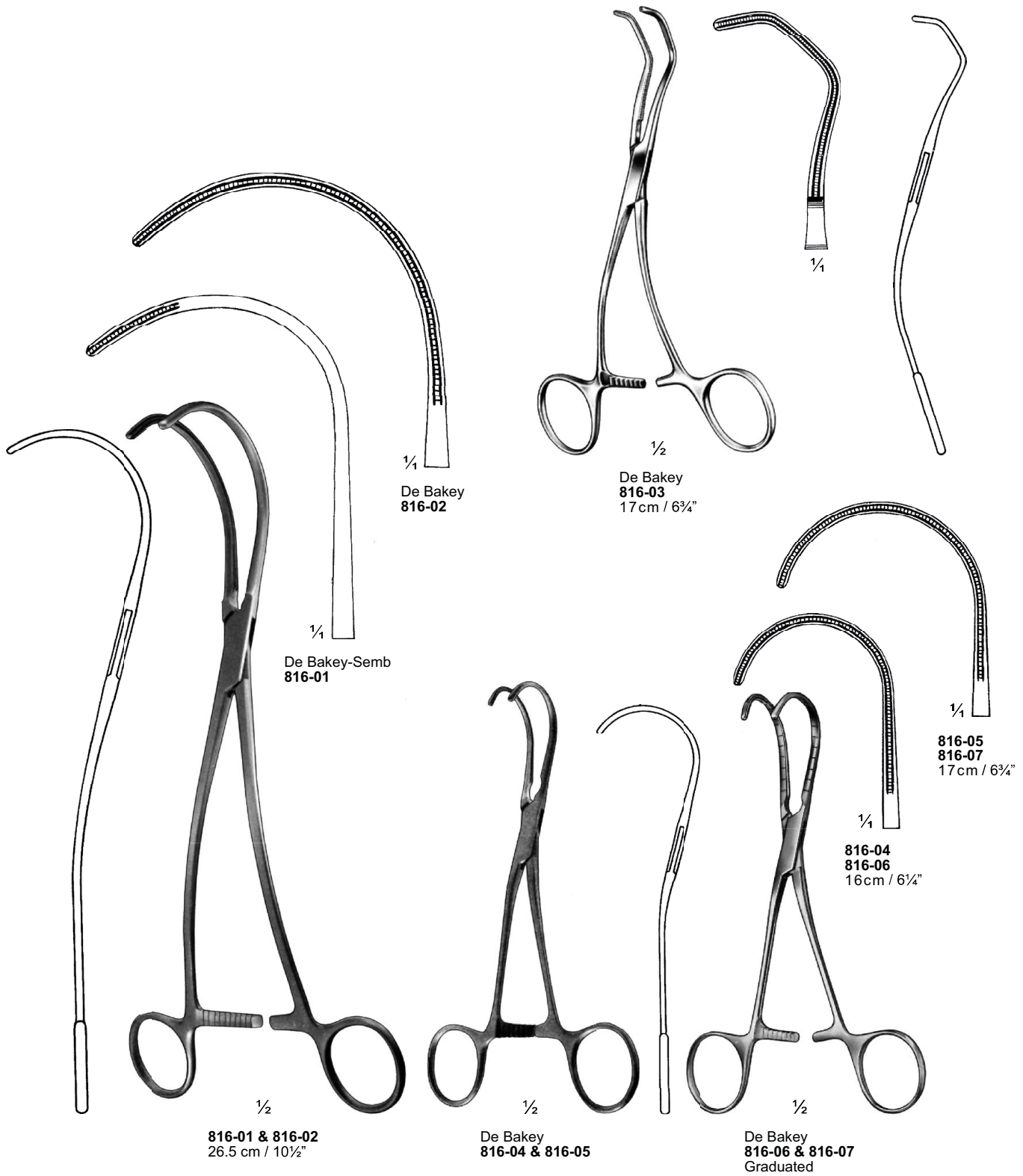

PINÇAS ATRAUMÁTICAS CARDIOVASCULAR

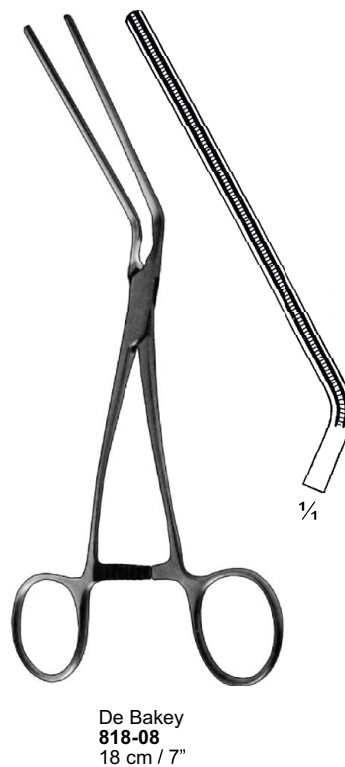
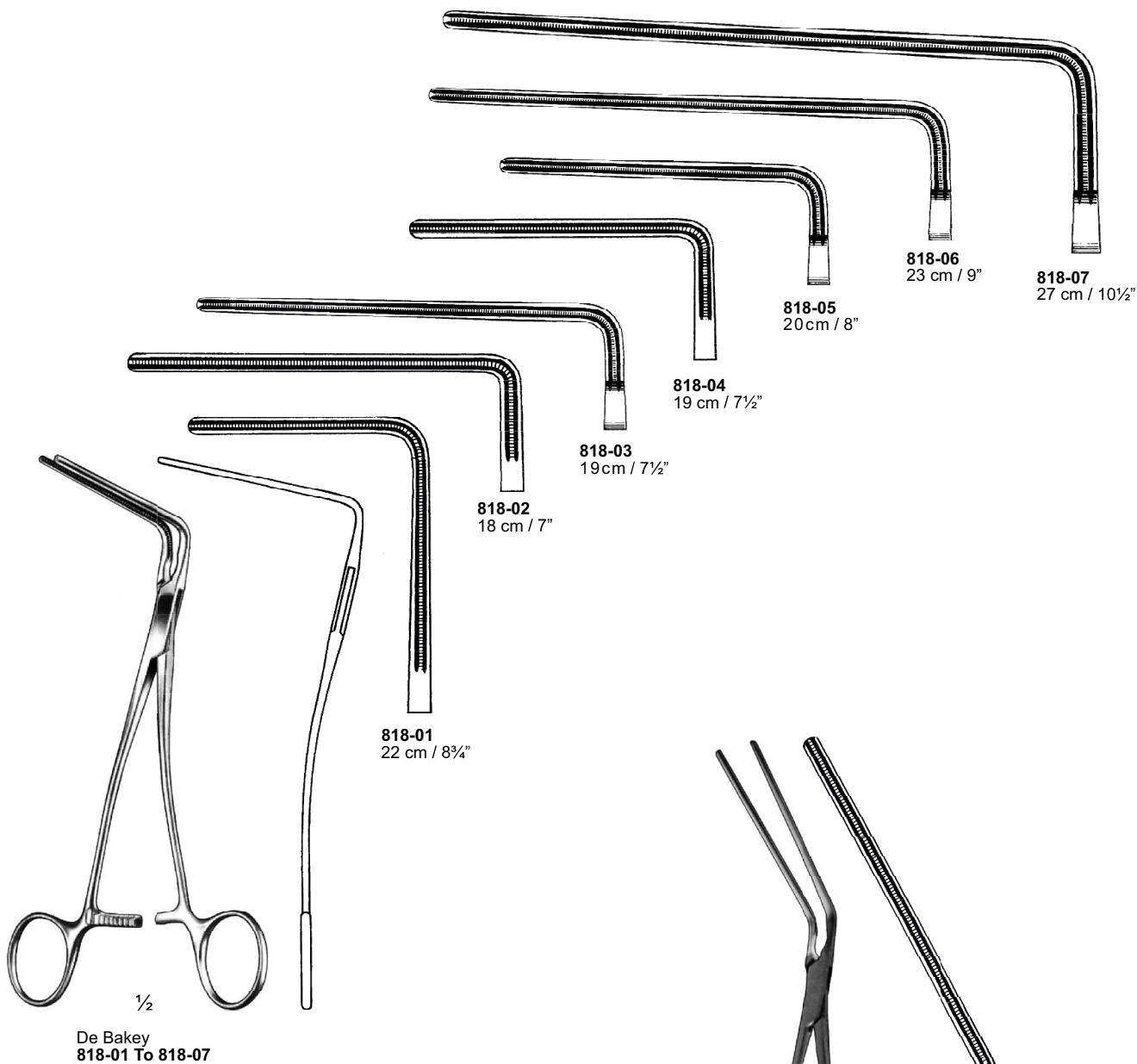

PINÇAS ATRAUMÁTICAS CARDIOVASCULAR

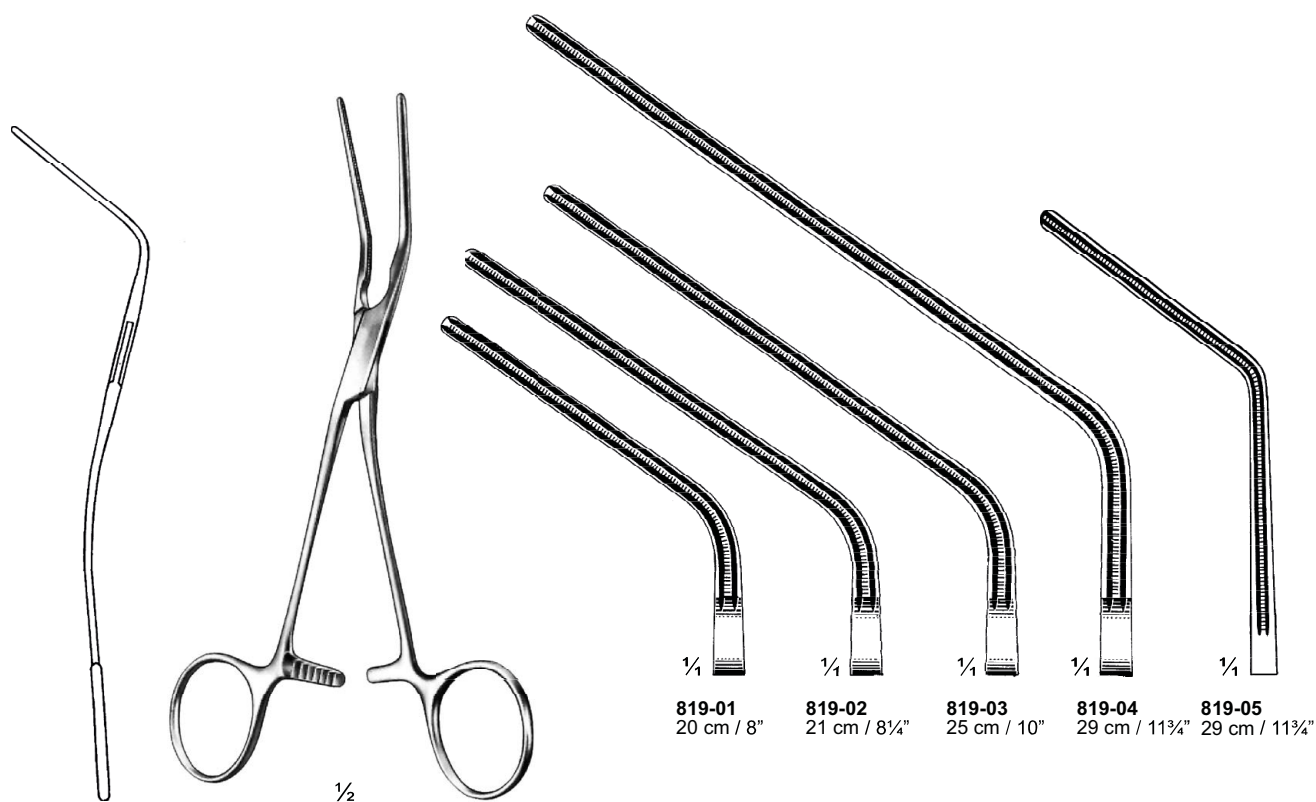

De Bakey
819-01 To 819-05

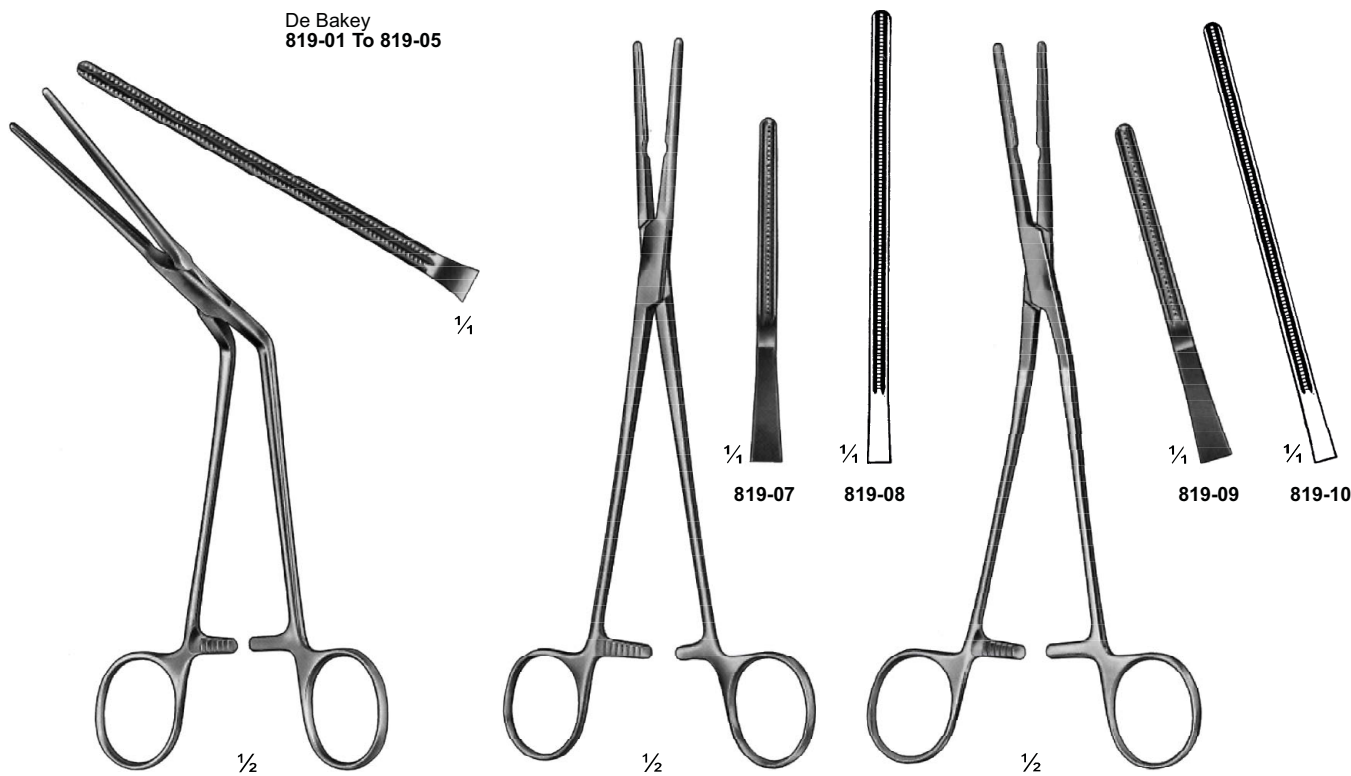

De Bakey
819-06
20 cm / 8"

De Bakey
819-07 & 819-08
21 cm / 8 1/4"

De Bakey
819-09 & 819-10
21 cm / 8 1/4"

PINÇAS ATRAUMÁTICAS CARDIOVASCULAR

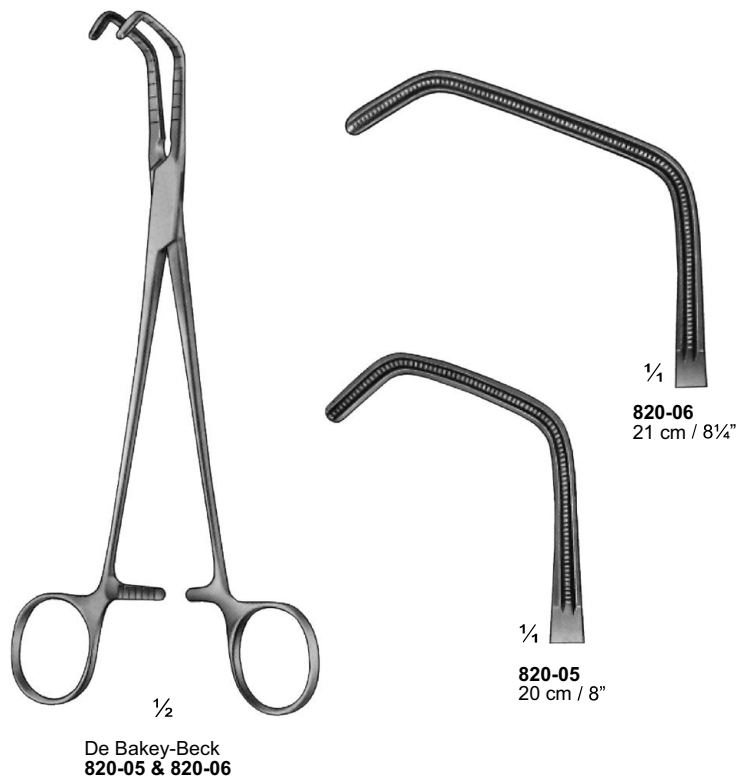
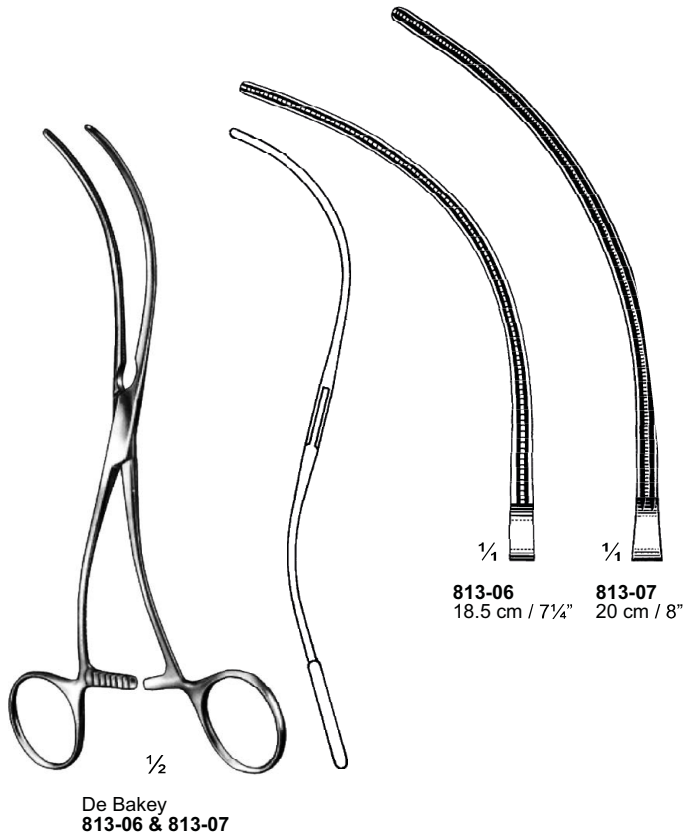

PINÇAS ATRAUMÁTICAS CARDIOVASCULAR

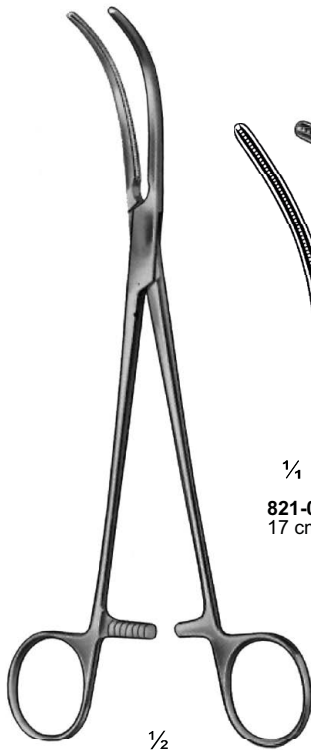

1/2

Glover
821-01 To 821-03

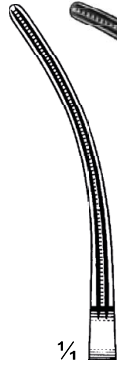

1/4
821-01
17 cm / 6 3/4"



1/4
821-02
21.5 cm / 8 1/2"



1/4
821-03
24.5 cm / 9 3/4"



1/2

Glover
821-04 & 821-05



1/4
821-04
17 cm / 6 3/4"



1/4
821-05
22 cm / 8 3/4"

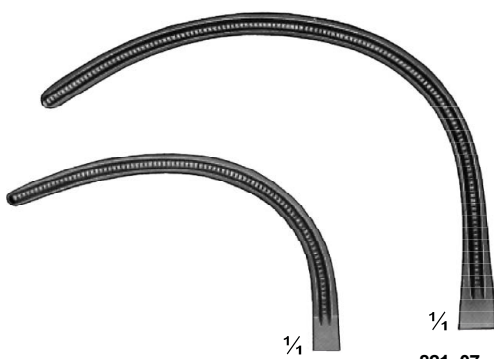

1/4
821-06
19.5 cm / 7 3/4"

1/4
821-07
21 cm / 8 1/4"



1/2

Glover
821-06 & 821-07



1/4
821-08
21 cm / 8 1/4"



1/4
821-09
22 cm / 8 3/4"

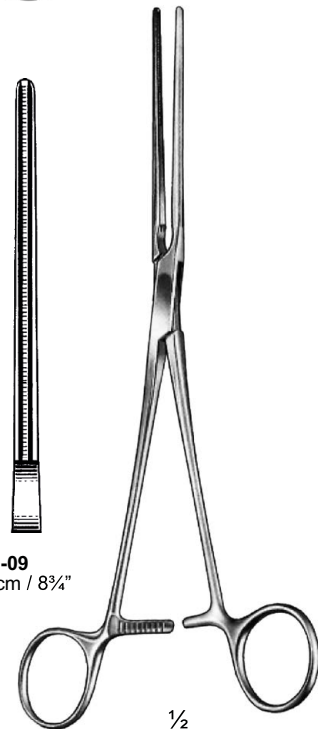

1/2

Potts
821-08 & 821-09

PINÇAS ATRAUMÁTICAS CARDIOVASCULAR

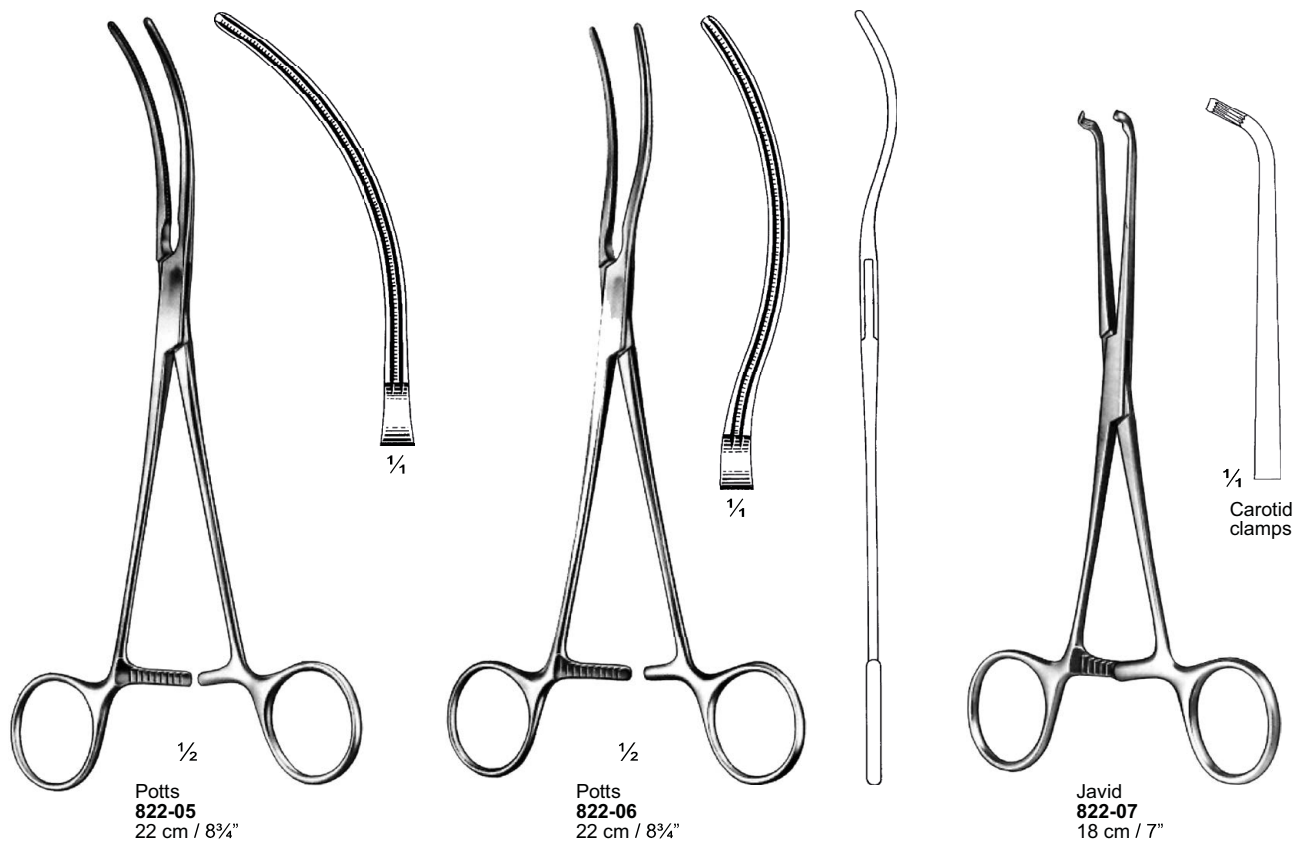
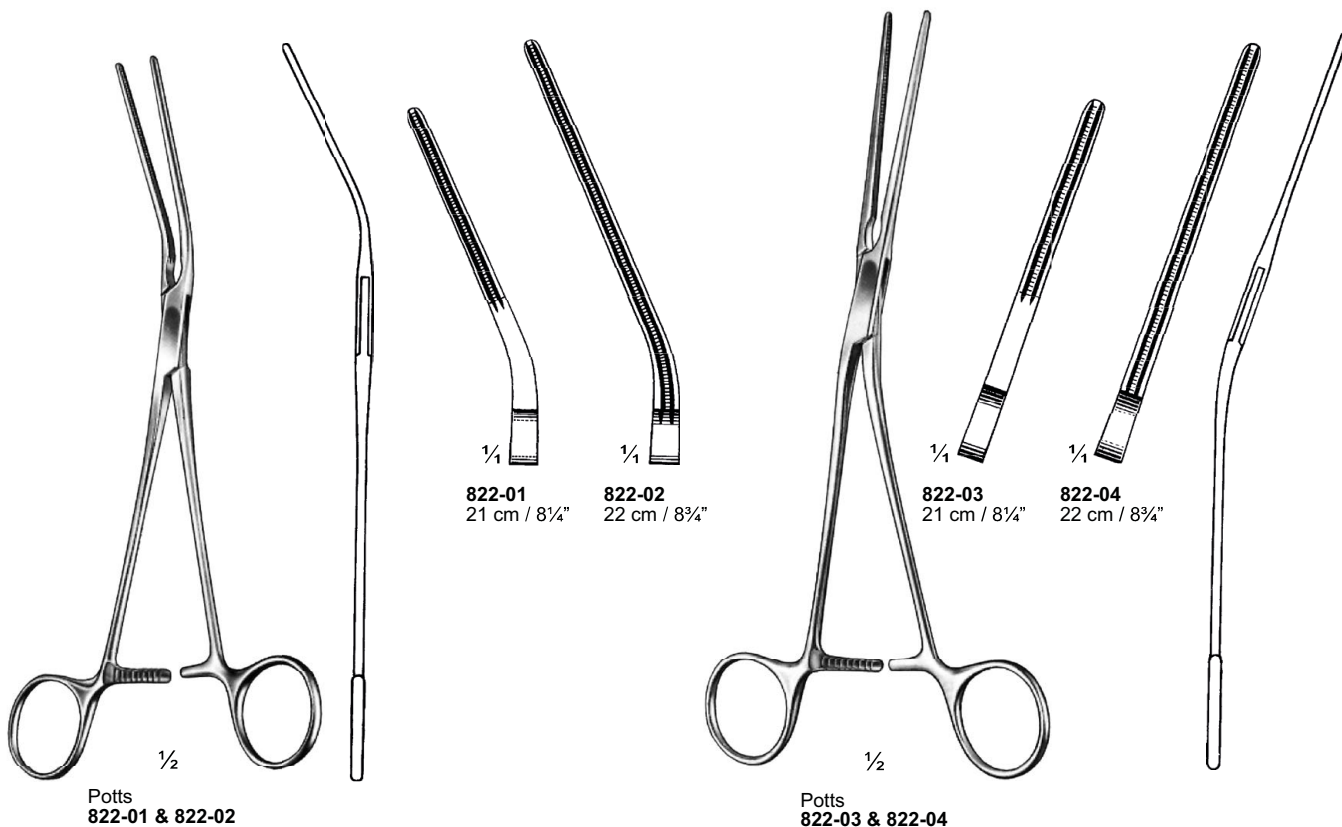

PINÇAS ATRAUMÁTICAS CARDIOVASCULAR

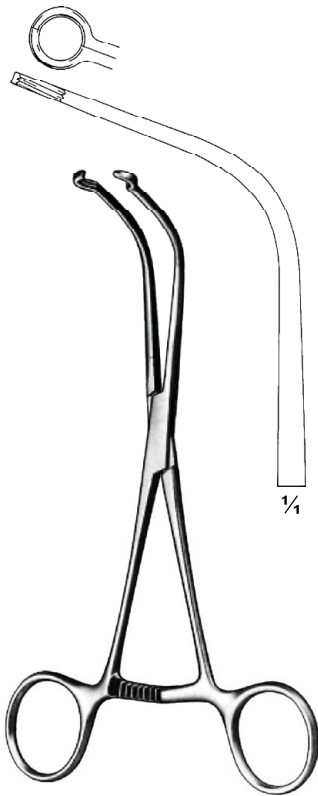

Javid
823-01
19cm / 7½"



823-02 To 823-05



823-02
21.5 cm / 8½"



823-03
23 cm / 9"

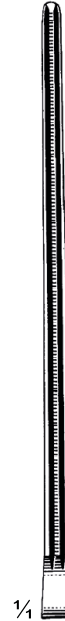

823-04
27 cm / 10½"



823-05
31.5 cm / 12½"



823-06 To 823-09

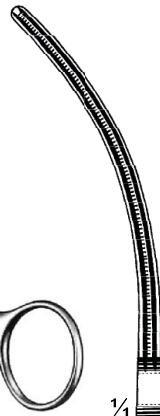

823-06
21.5 cm / 8½"

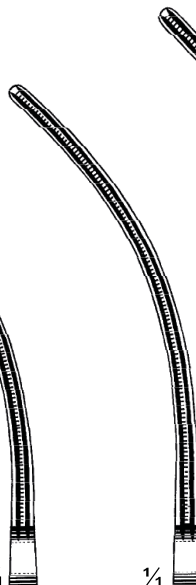

823-07
23 cm / 9"

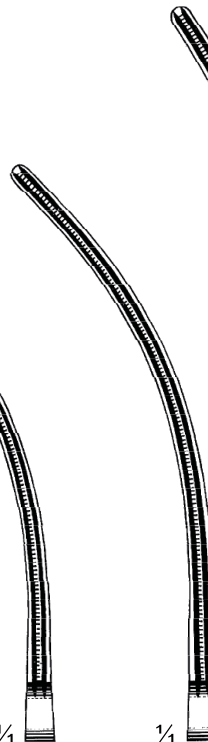

823-08
27 cm / 10½"

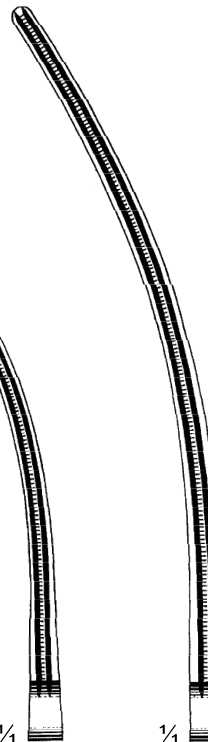

823-09
31.5 cm / 12½"

PINÇAS ATRAUMÁTICAS CARDIOVASCULAR

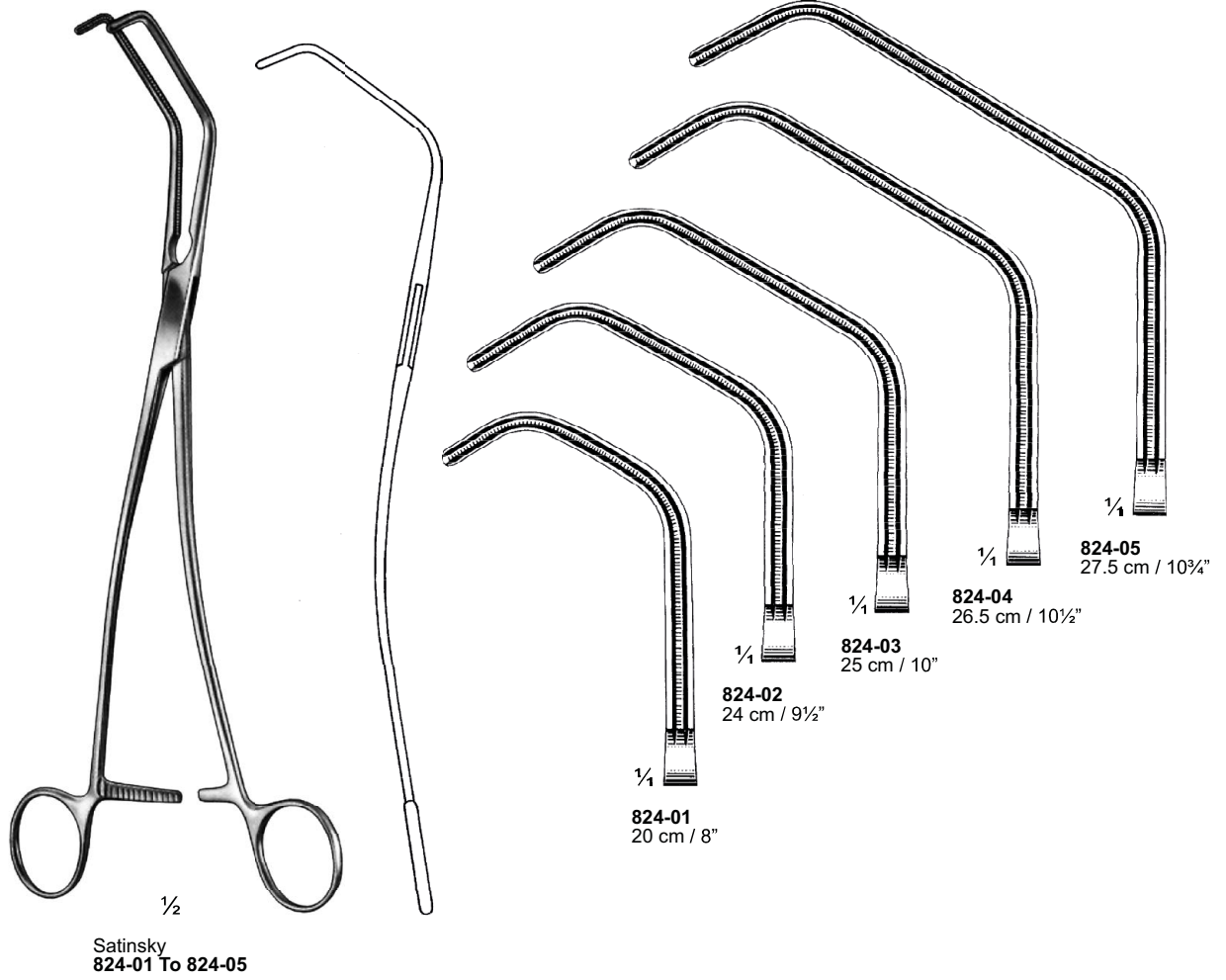

PINÇAS ATRAUMÁTICAS CARDIOVASCULAR



$\frac{1}{4}$
Lambert-Kay
825-01
21 cm / 8 $\frac{1}{4}$ "



$\frac{1}{4}$
Lambert-Kay
825-02
21.5 cm / 8 $\frac{1}{2}$ "



$\frac{1}{4}$
Lambert-Kaya Modif.
825-03
25 cm / 10"

$\frac{1}{2}$
825-01 To 825-03

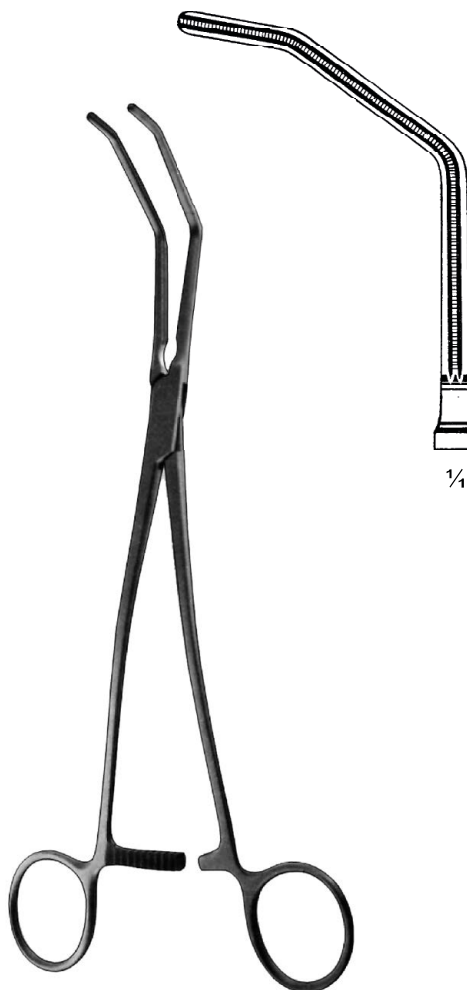

Glover-De Bakey
825-04
23 cm / 9"

$\frac{1}{4}$

PINÇAS ATRAUMÁTICAS CARDIOVASCULAR

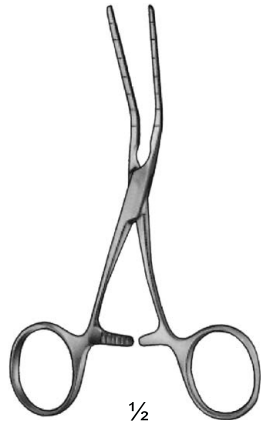

Castaneda
826-04 To 826-07
Graduated



826-04
12.5 cm / 5"

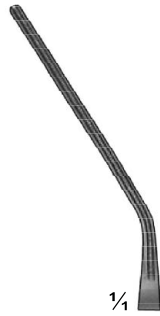

826-05
12 cm / 4 3/4"
30°



826-06
12 cm / 4 3/4"
45°



826-07
10.5 cm / 4 1/8"
90°

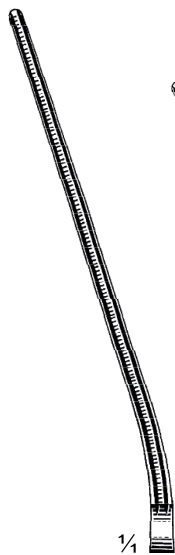

827-05
20 cm / 8"

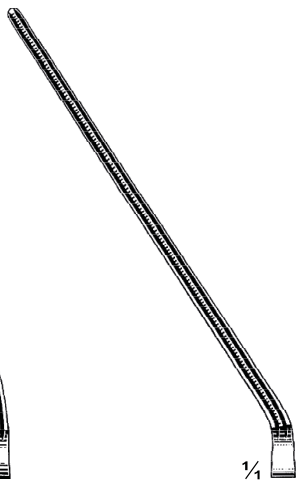

827-06
19 cm / 7 1/2"

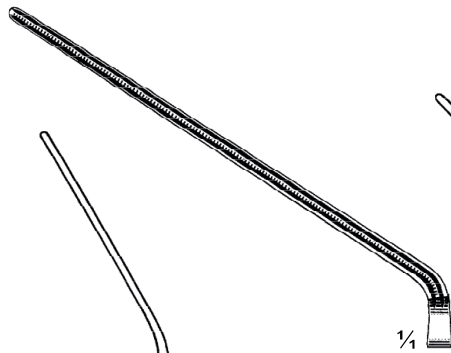

827-07
18cm / 7"

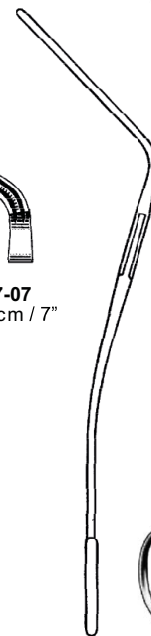

Leland-Jones
827-05 To 827-07

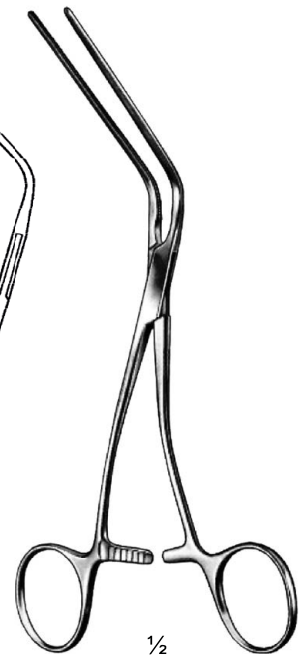

PINÇAS ATRAUMÁTICAS CARDIOVASCULAR

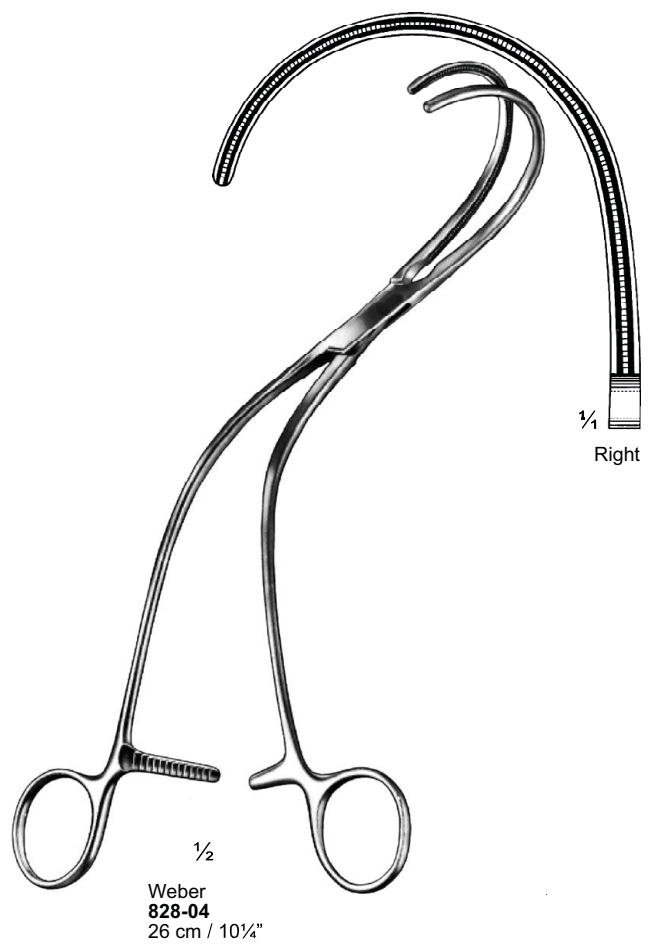
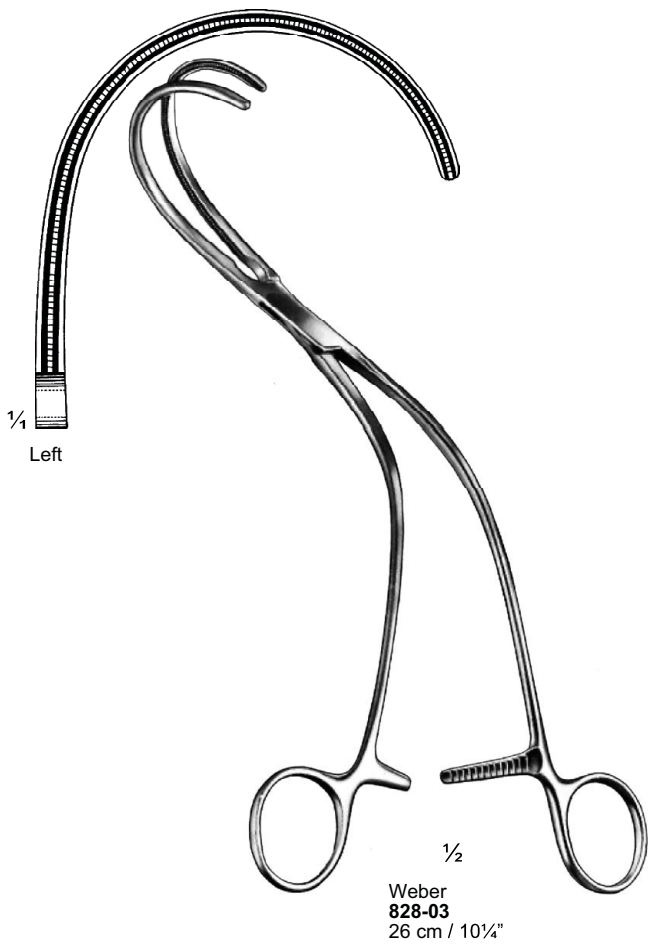

PINÇAS ATRAUMÁTICAS CARDIOVASCULAR

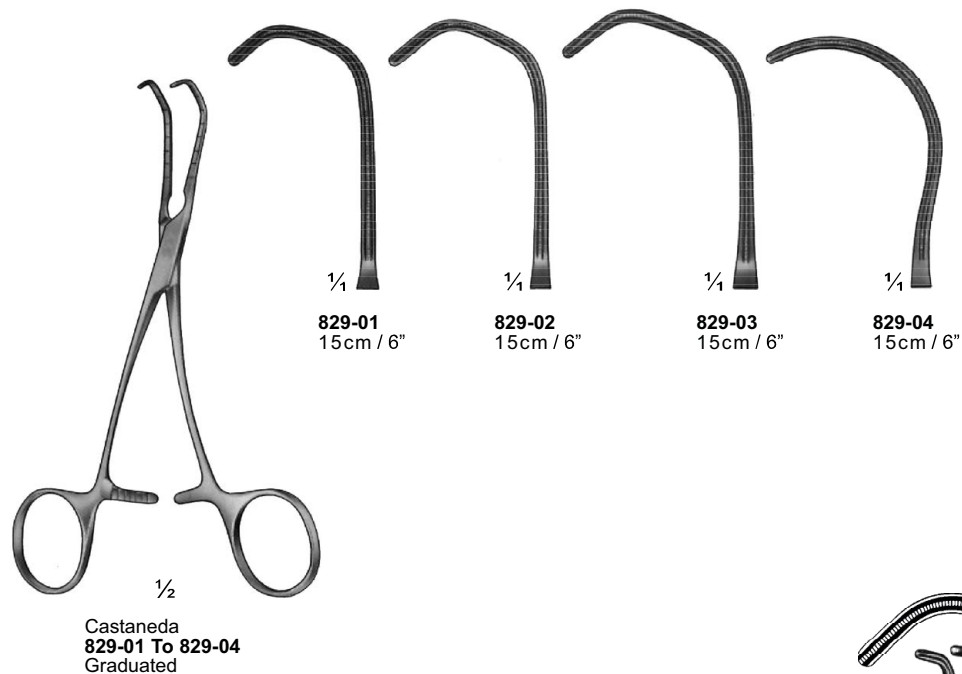

PINÇAS ATRAUMÁTICAS CARDIOVASCULAR

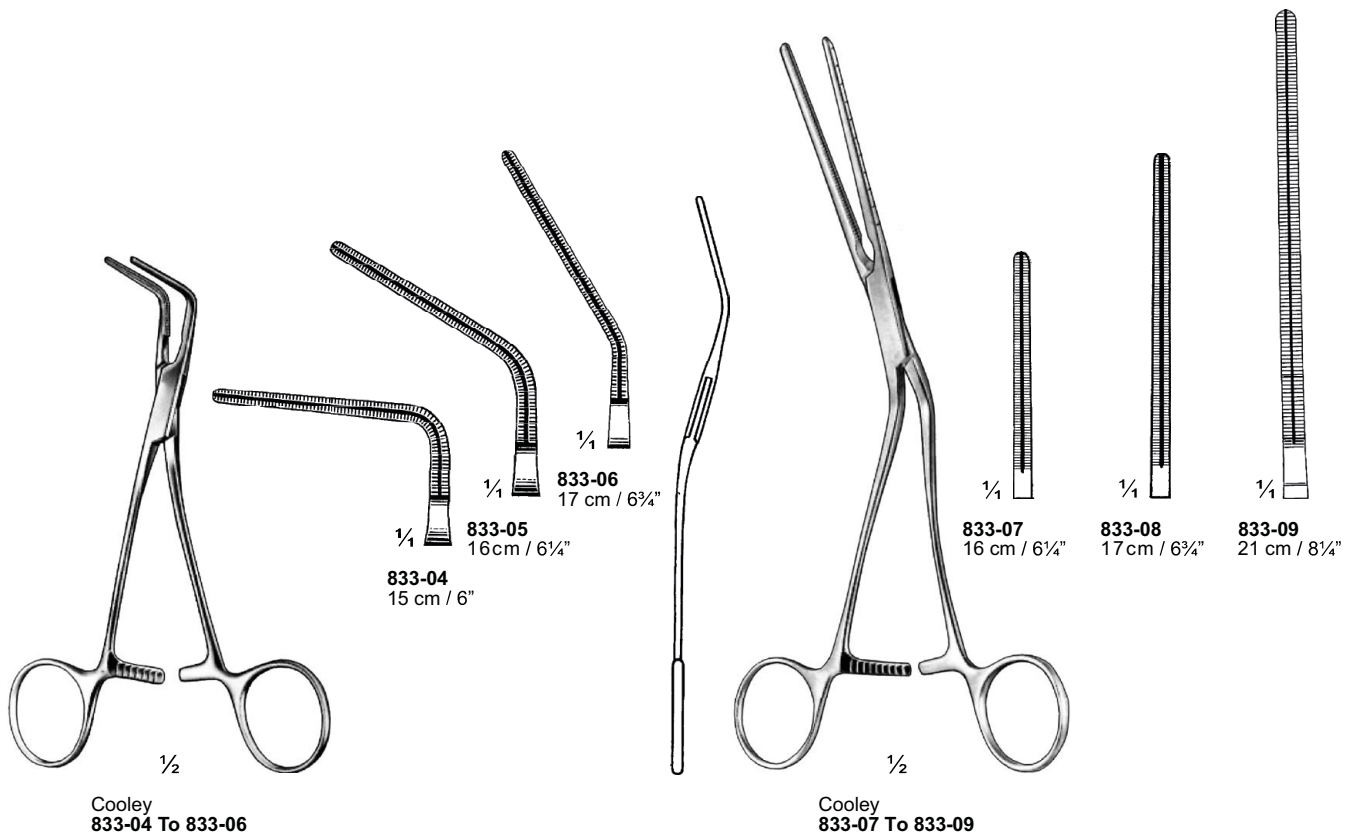
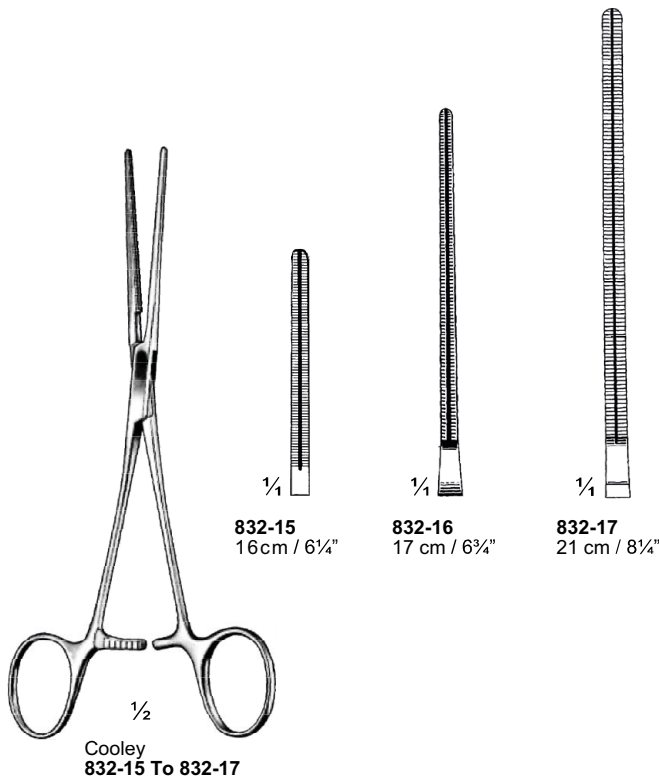

PINÇAS PEDIÁTRICAS DELICADAS

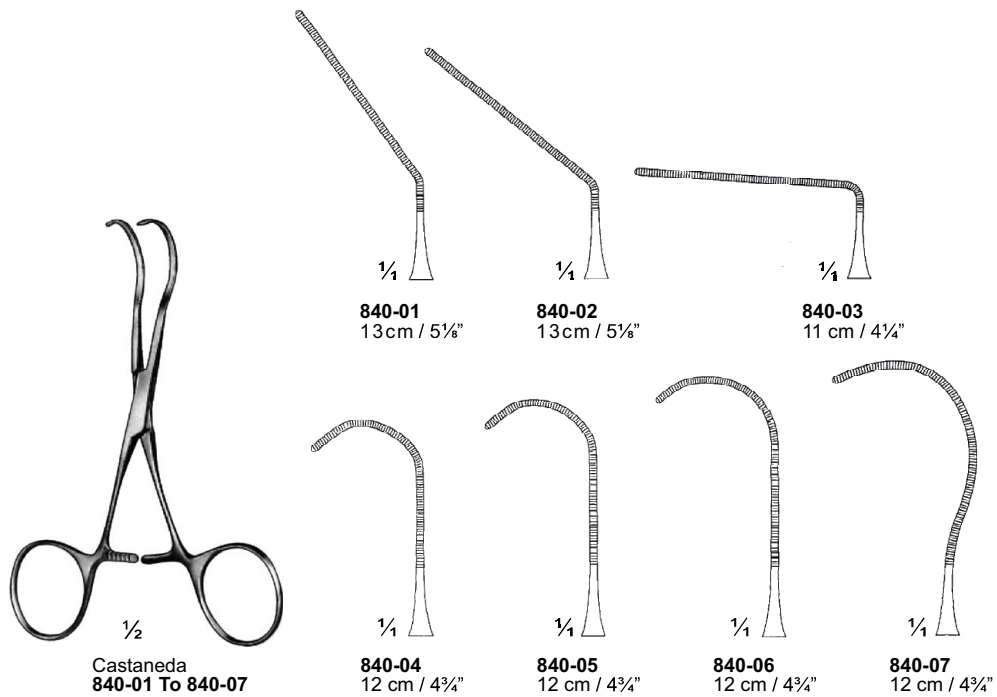
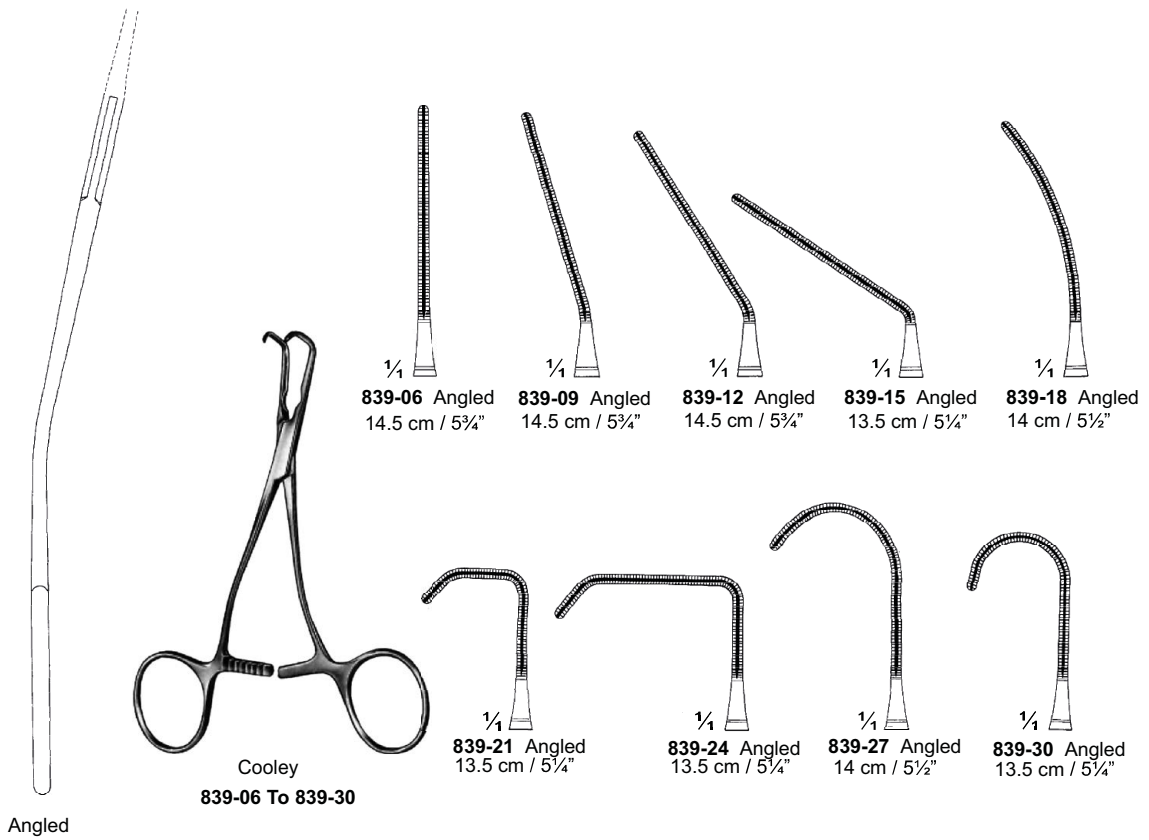

CLAMPS PARA AORTA

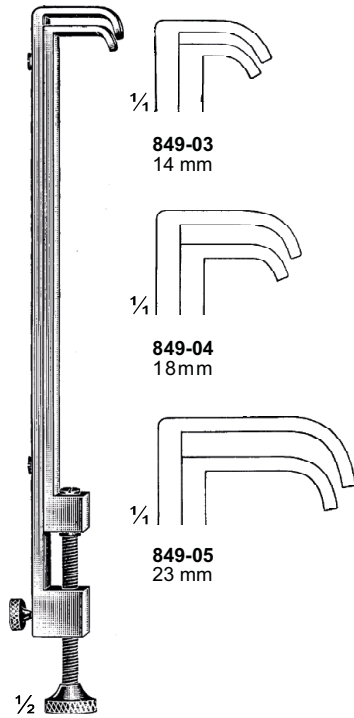

Blalock
849-03 To 849-05
20 cm / 8"

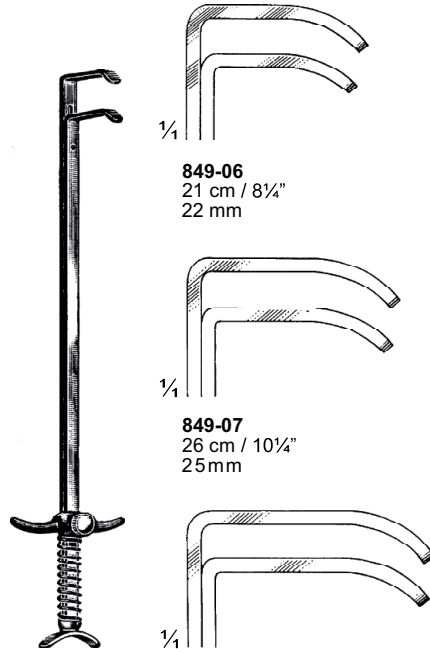

Blalock
849-06 To 849-08
26 cm / 10 1/4"
32 mm

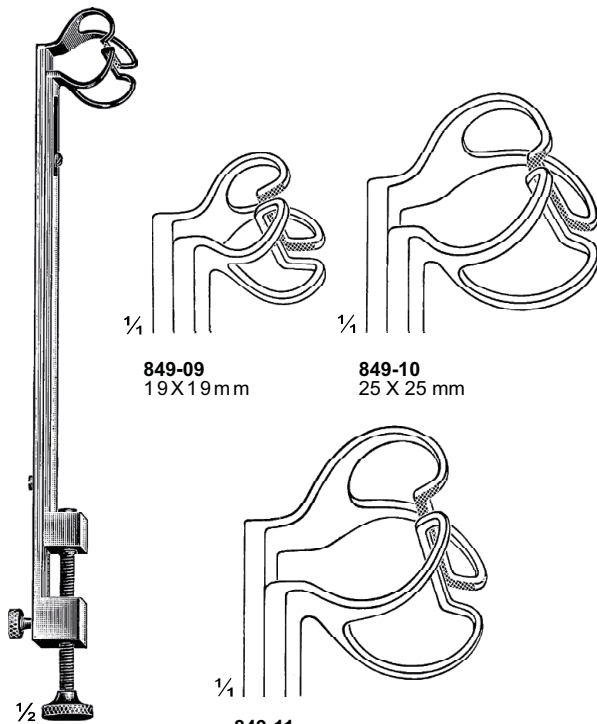

Pott (Johns-Hopkins)
849-09 To 849-11
20 cm / 8"

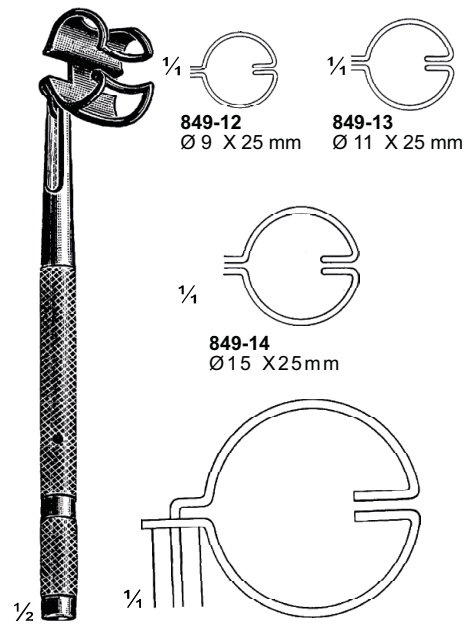

Potts-Smith
849-12 To 849-15
18cm / 7"

849-15
Ø 28 X 35 mm

PINÇAS PARA REMOÇÃO DE PEDRAS

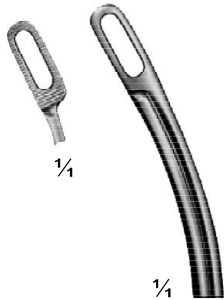
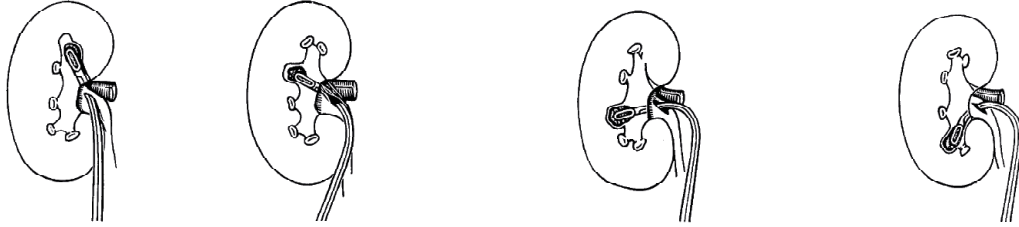

864-01
23 cm / 9"

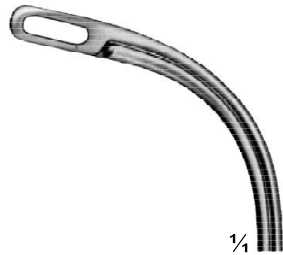

864-02
22 cm / 8 3/4"

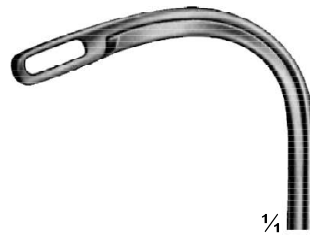

864-03
22 cm / 8 3/4"



864-04
22 cm / 8 3/4"

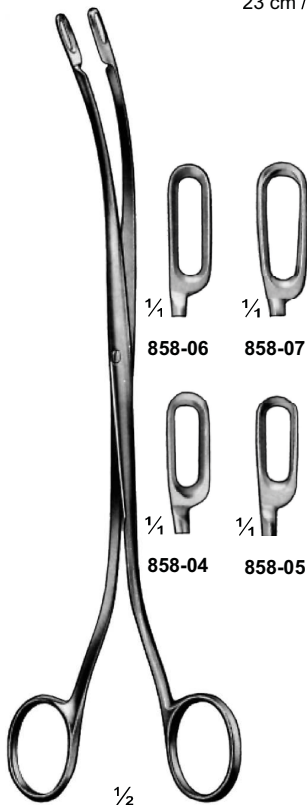

Desjardins
858-04 To 858-07
23 cm / 9"

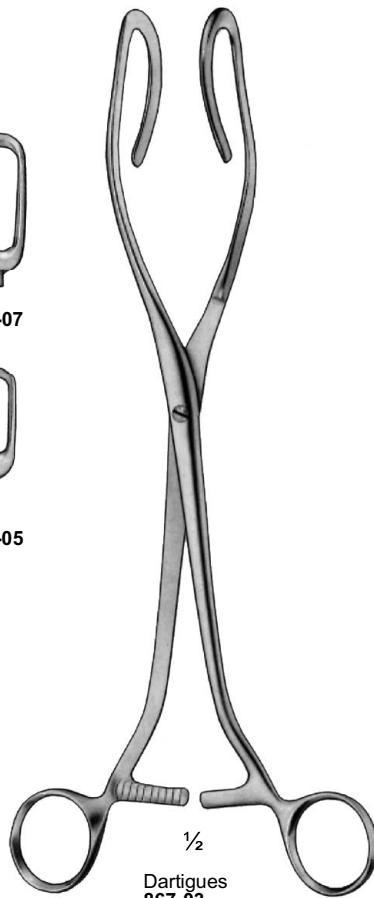

Dartigues
867-03
25 cm / 10"

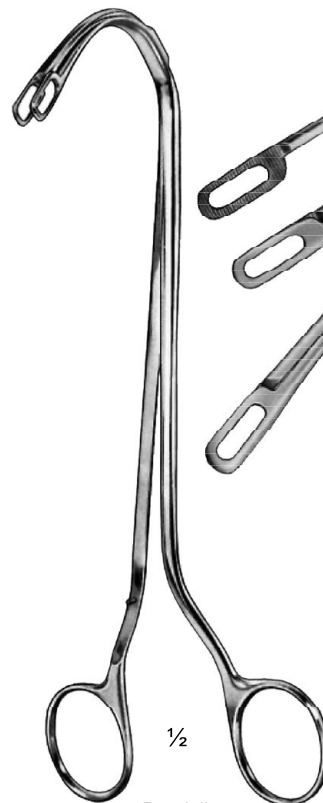

Randall
864-01 To 864-06

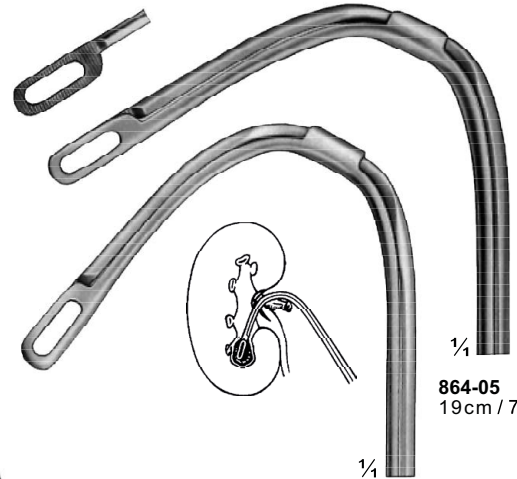

864-05
19 cm / 7 1/2"

864-06
19 cm / 7 1/2"

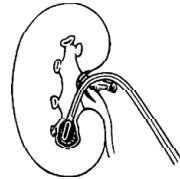

PINÇAS PARA ÚTERO

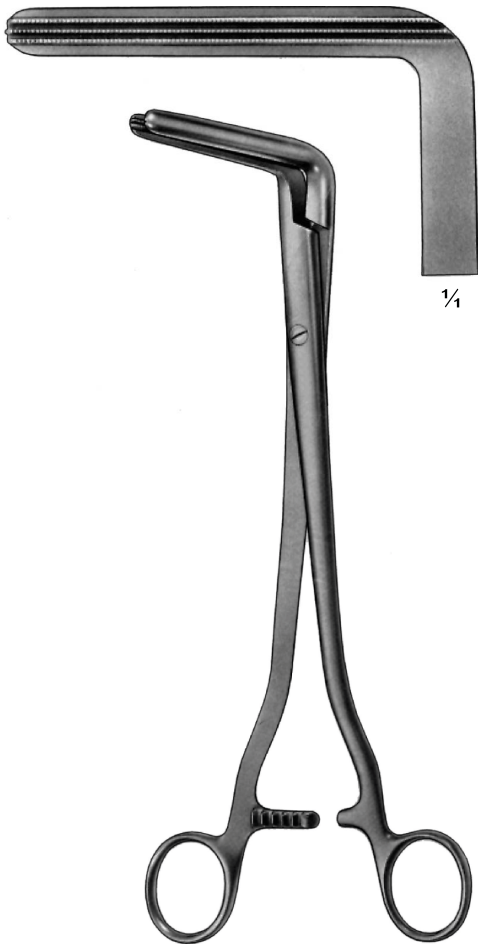

Wertheim
868-03
25 cm / 10"
Anlge and pressure clamp
Atrauma toothed

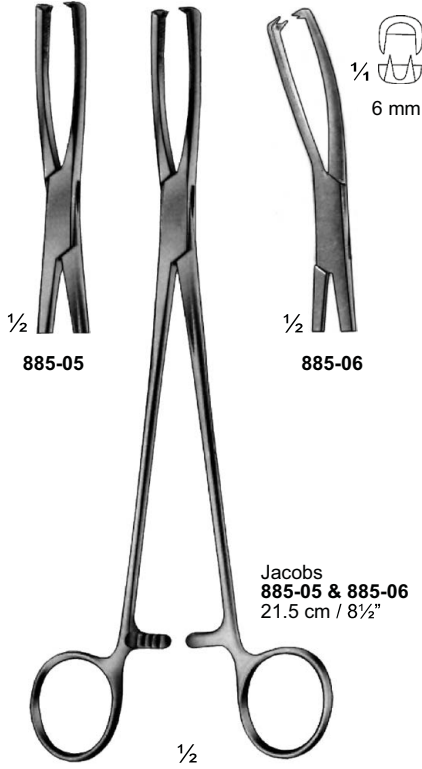

1/2
885-05

1/2
885-06

Jacobs
885-05 & 885-06
21.5 cm / 8 1/2"



Pozzi
881-04
25 cm / 10"

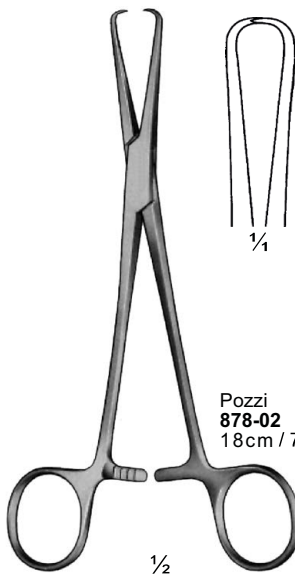

Pozzi
878-02
18cm / 7"

PINÇAS PARA ÚTERO

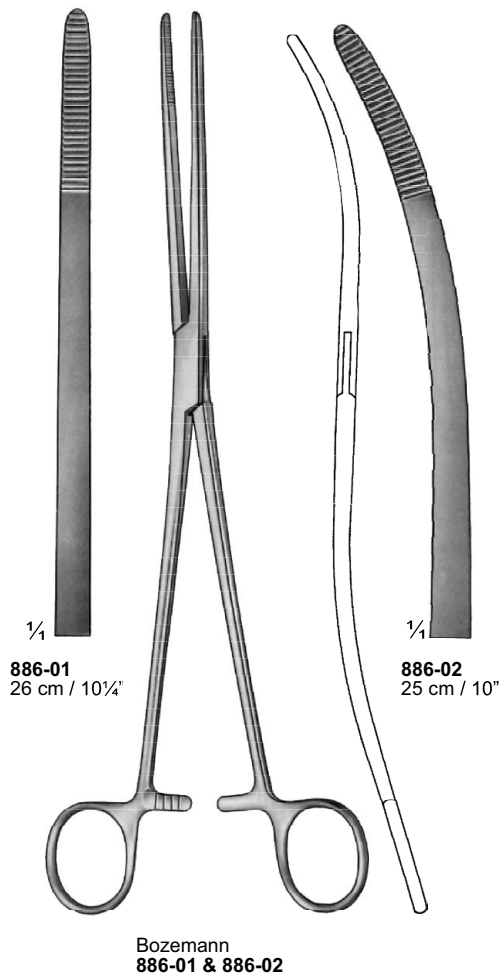

PINÇAS PARA BIÓPSIA DO COLO UTERINO

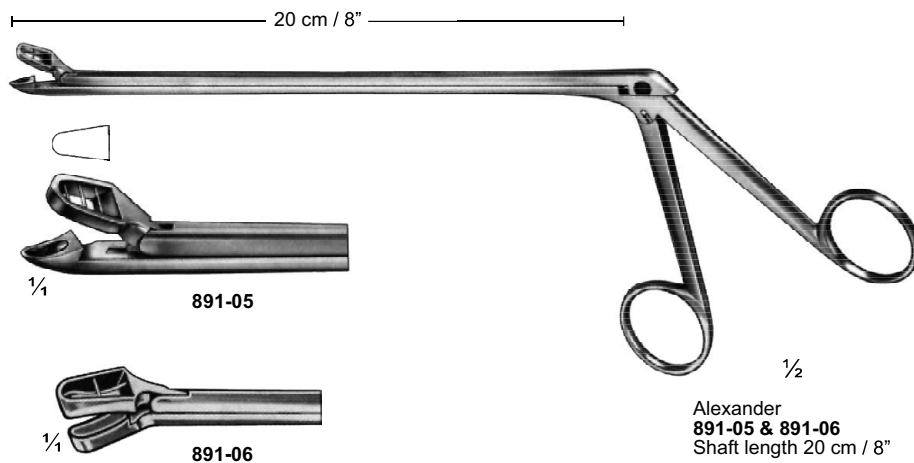
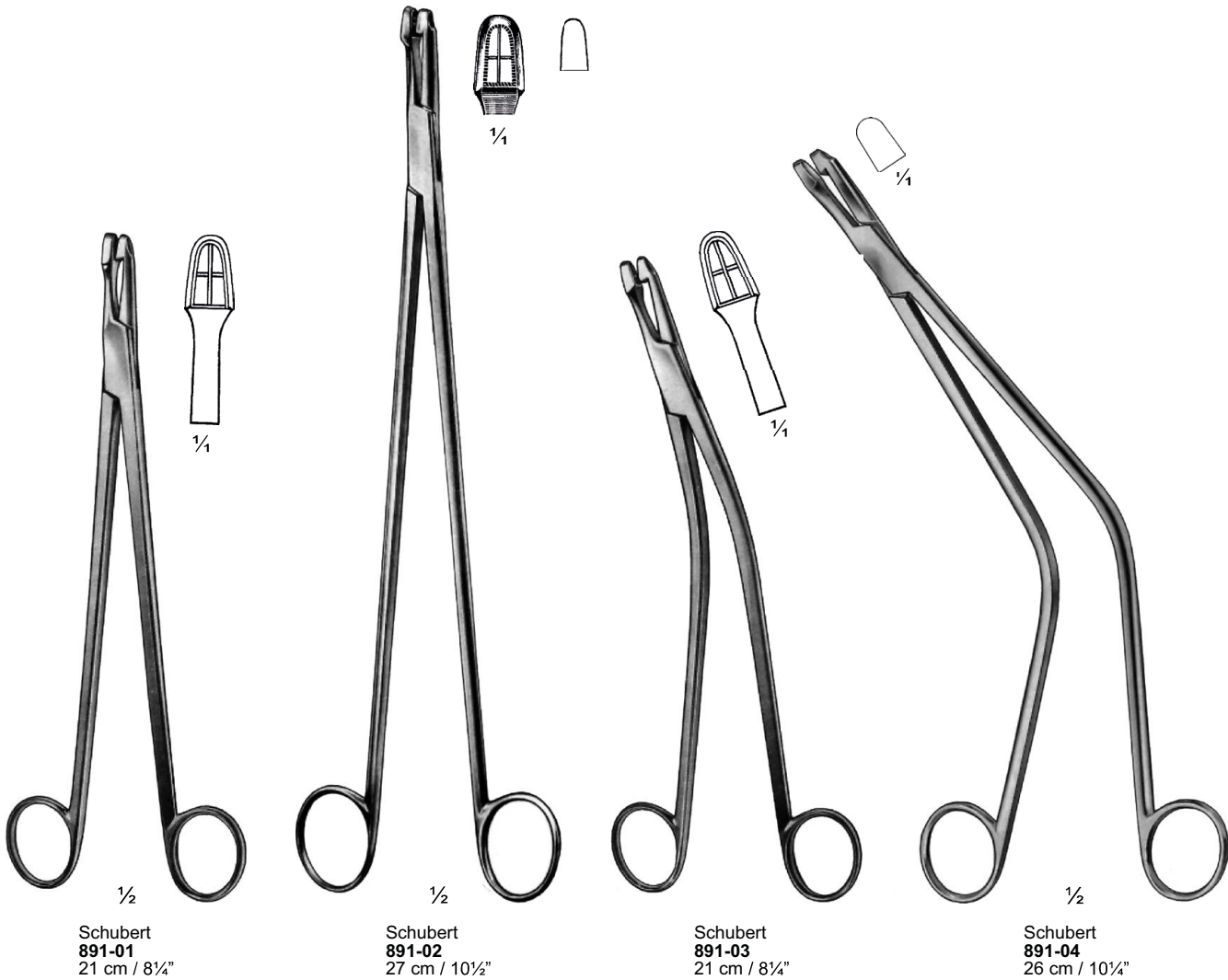

PINÇAS PARA BIÓPSIA DO COLO UTERINO



Van Doren
892-05
25 cm / 10"

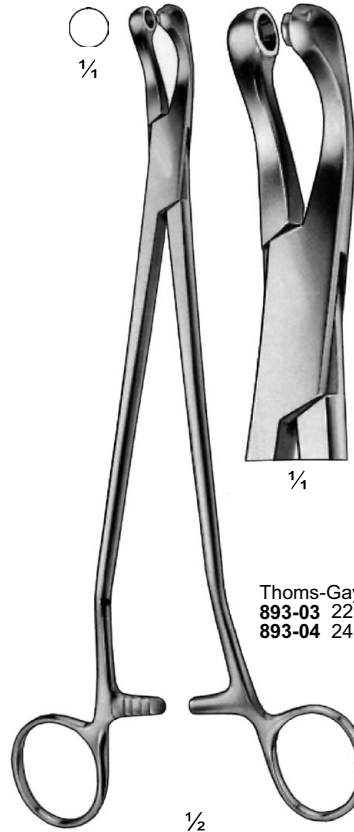

Thoms-Gaylor
893-03 22 cm / 8 3/4"
893-04 24 cm / 9 1/2"



Schubert
892-01 Str
892-02 Sideways cur
23.5 cm / 9 1/4"



Faure
894-04 21 cm / 8 1/4"
894-05 24 cm / 9 1/2"

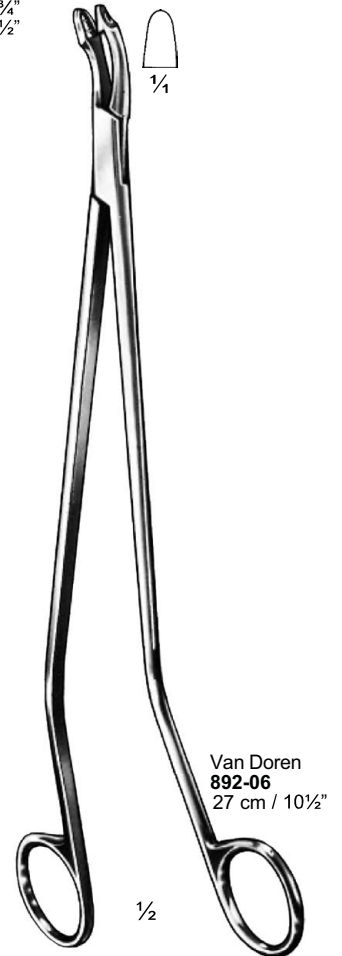

Van Doren
892-06
27 cm / 10 1/2"

PINÇA PARA ABERTURA DO CÓLO DO ÚTERO

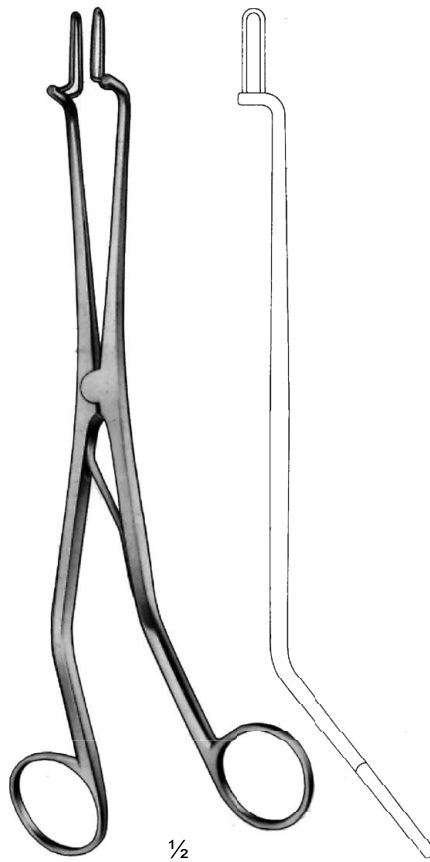
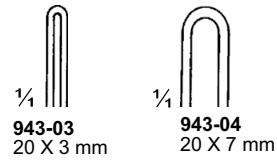
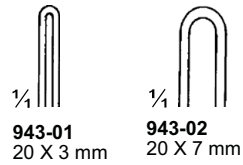

Kogan
943-01 & 943-02
24 cm / 9½"
Endospecula for cervix
and urethra, without ratchet



Kogan
943-03 & 943-04
24 cm / 9½"
Endospecula for cervix
and urethra, with scale-ratchet
and fixing screws

PINÇA OBSTÉTRICA

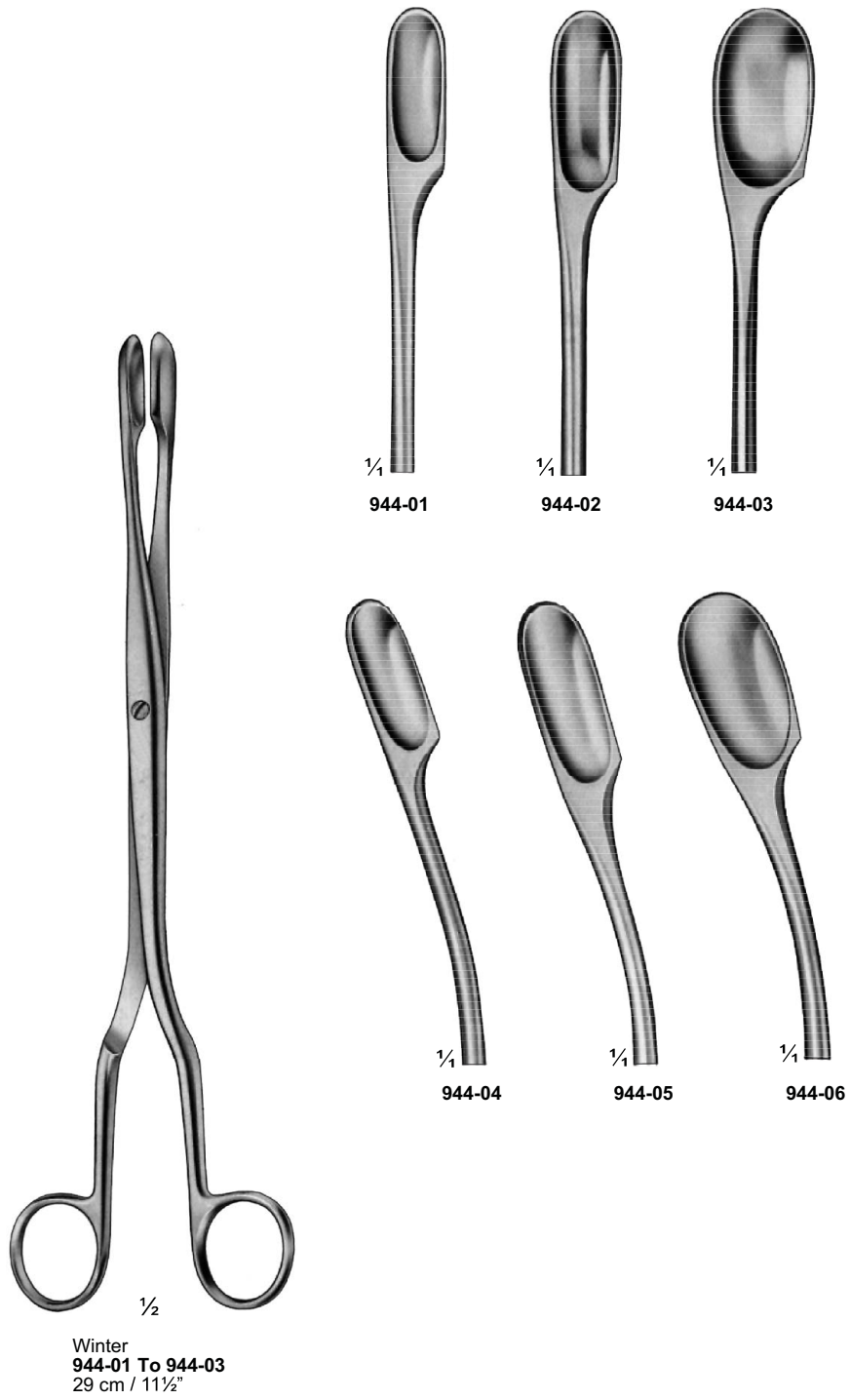

PINÇA OBSTÉTRICA



Winter
945-01 To 945-03
29 cm / 11½"

PINÇAS OBSTÉTRICAS



Simpson-Braun
959-02
30 cm / 12"

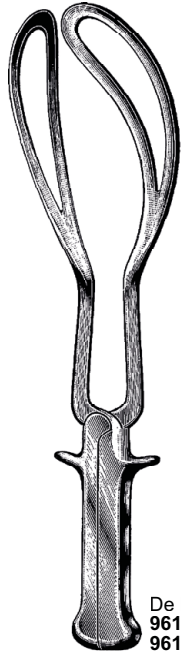

De Lee
961-03 36 cm / 14¼"
961-04 39 cm / 15½"

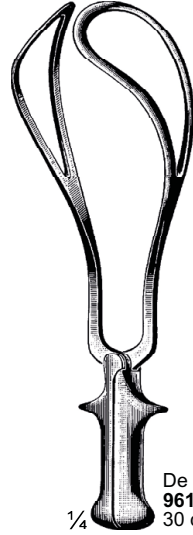

De Lee
961-02
30 cm / 12"



Kielland
960-02 39 cm / 15½"
960-03 42 cm / 16¾"



Simpson-Braun
959-03
35 cm / 14"

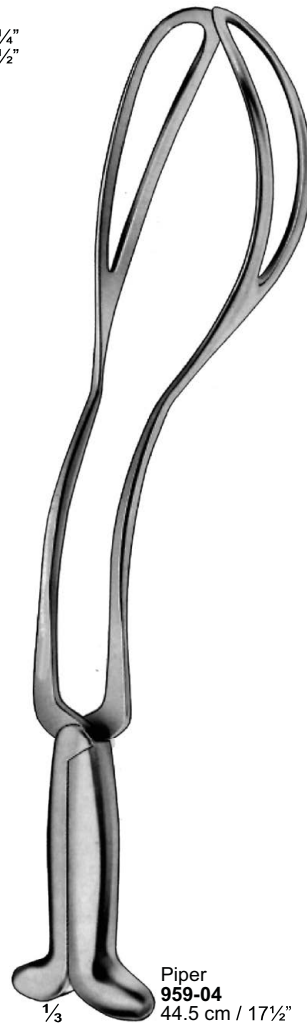

Piper
959-04
44.5 cm / 17½"

PINÇAS PARA INSTRUMENTOS

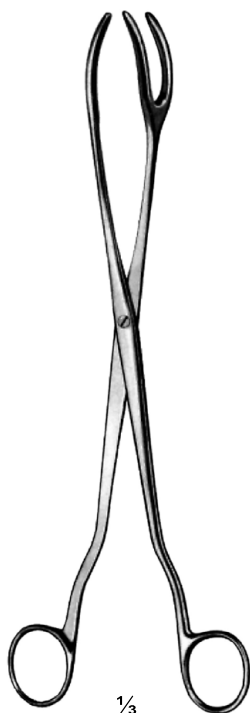

Collin
965-10 20 cm / 8"
965-11 25 cm / 10"
965-12 30 cm / 12"

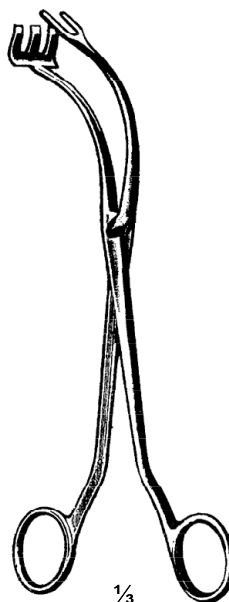

Collin
966-13 24 cm / 9½"
966-14 30 cm / 12"



Tecnologia Alemã **Pius Lang:**



Distribuído por:



www.stetten.com.br

Rua Luiza Grinalda, 550, Ed. Plaza Top Center, sala 201, Centro, Vila Velha/ES. CEP 29100-240
27 3534-5752 • admfarbo@farbomedical.com.br