



stetten
INSTRUMENTAIS CIRÚRGICOS

BOCA

ABRIDOR DE BOCA



Denhardt
562-02
12.5 cm / 5"
Denhardt
562-01
12 cm / 4¾"

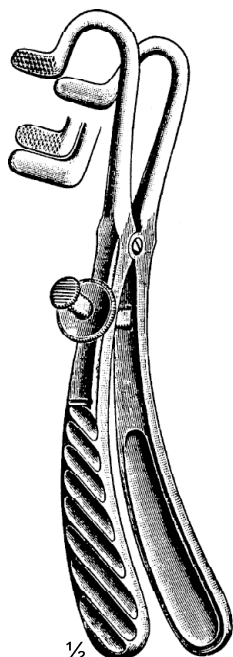

Mason
562-15 14 cm / 5½"
562-16 16 cm / 6¼"
562-17 18 cm / 7"
562-18 20 cm / 8"



Heister
563-01
13cm / 5½"

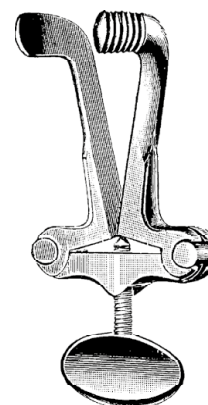

Heister
563-02
13cm / 5½"

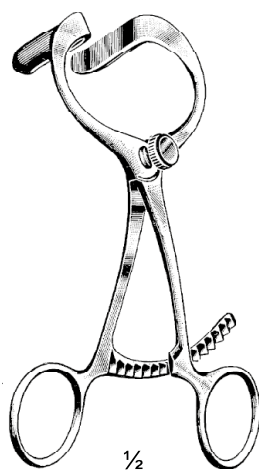

Doyen-Collin
563-03 13 cm / 5½"
563-04 15cm / 6"

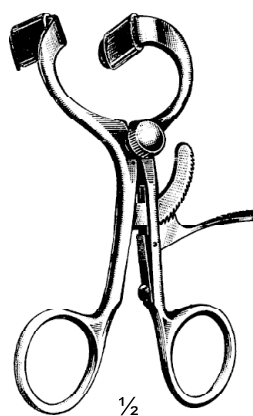

Molt
563-05 11 cm / 4¼"
563-06 14 cm / 5½"

ABRIDOR DE BOCA



Doyen-Jansen
563-07 10 cm / 4"
563-08 15 cm / 6"

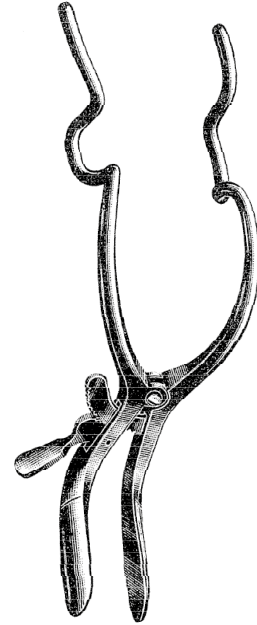

Jennings
563-10 11cm / 4¼"
563-11 13cm / 5¼"

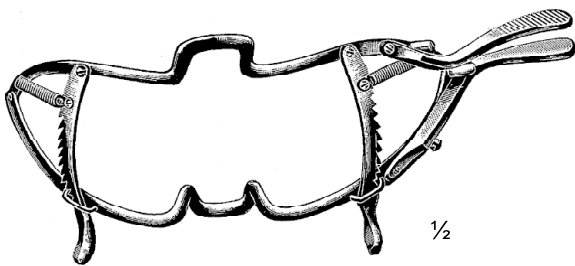

Whitehead
564-09 9cm / 3½"
564-10 11 cm / 4¼"
564-11 13 cm / 5¼"
564-12 15cm / 6"

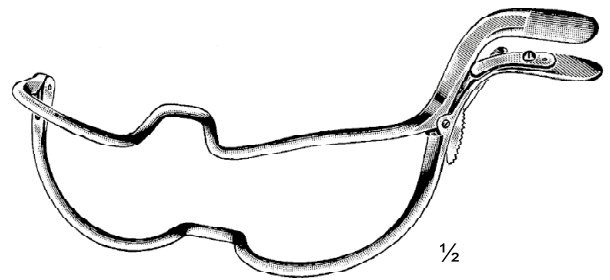

Jennings
564-01 9 cm / 3½"
564-02 11 cm / 4¼"
564-03 13 cm / 5¼"
564-04 15 cm / 6"

ABRIDOR DE BOCA



Jennings

- 565-01 9 cm / 3 1/2"
- 565-02 11 cm / 4 1/4"
- 565-03 13 cm / 5 1/8"
- 565-04 15 cm / 6"



Oringer

- 565-05 No. 0, For children
- 565-06 No 1
- 565-07 No. 2
- 565-08 No. 3
- 565-09 Complete set No. 0-3

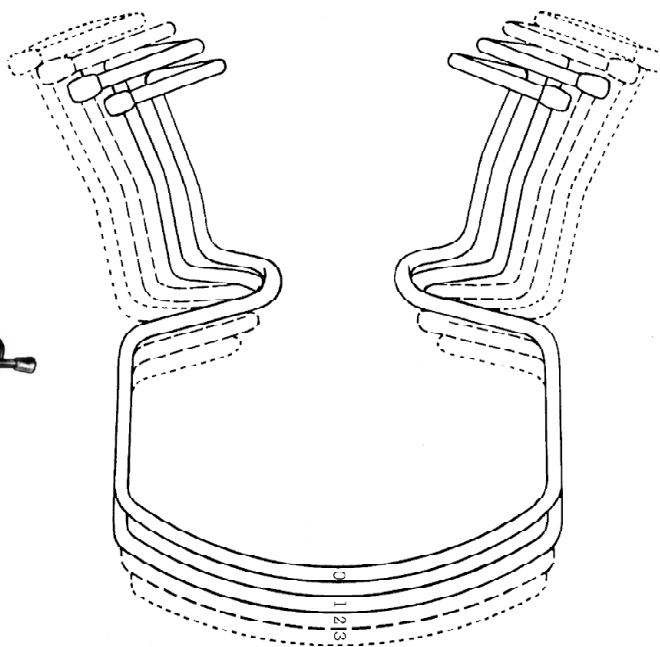

- No. 1
- No. 2
- No. 3

Kilner-Dott

- 565-10
- Complete consisting :
- 1 Frame
- 3 Blades No. 1, 2, 3



- No. 1
- No. 2
- No. 3

Kilner-Russel

- 565-11
- Complete consisting :
- 1 Frame
- 3 Blades No. 1, 2, 3

ABRIDOR DE BOCA

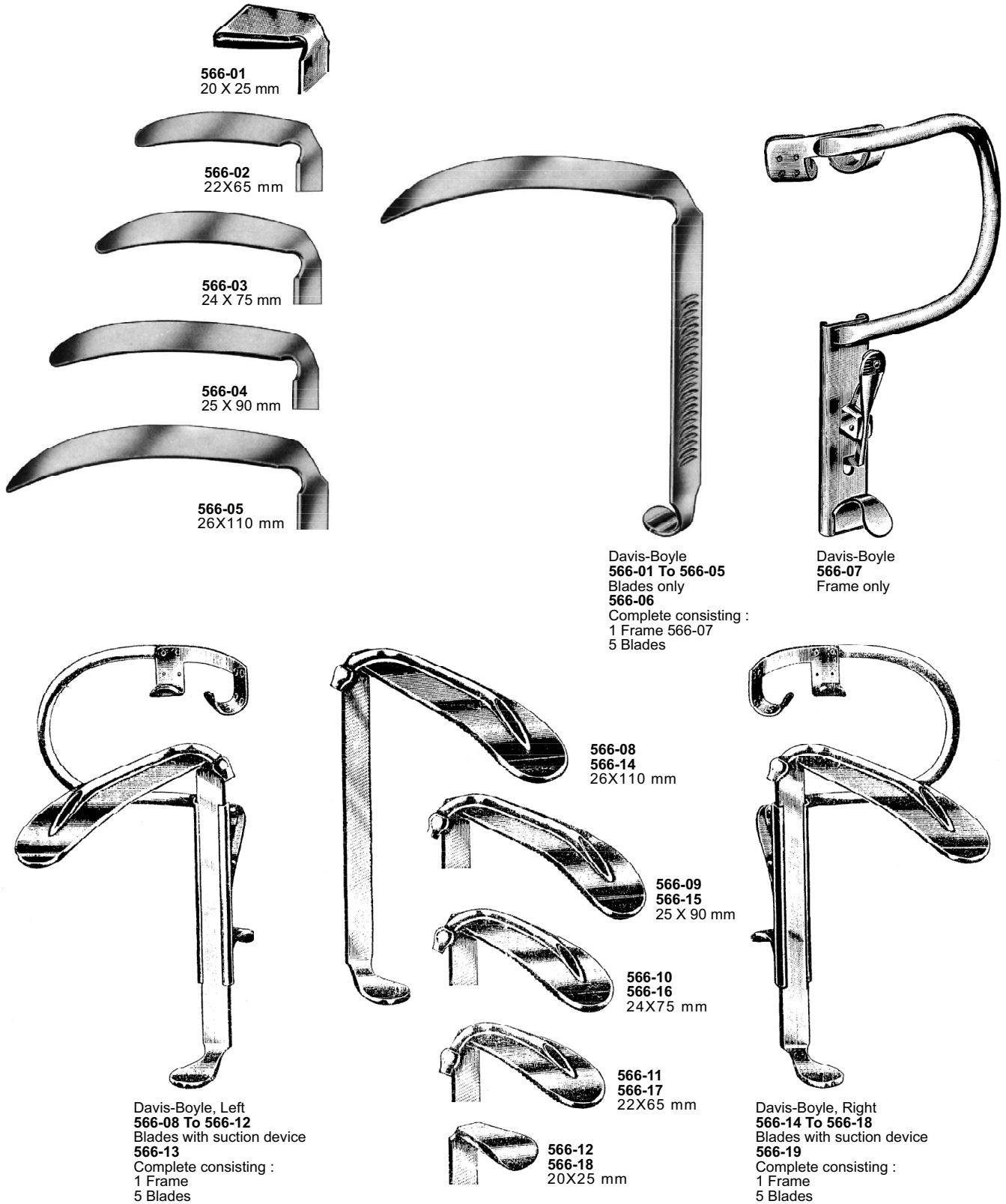

566-01
20 X 25 mm

566-02
22X65 mm

566-03
24 X 75 mm

566-04
25 X 90 mm

566-05
26X110 mm

Davis-Boyle
566-01 To 566-05
Blades only
566-06
Complete consisting :
1 Frame 566-07
5 Blades

Davis-Boyle
566-07
Frame only

566-08
566-14
26X110 mm

566-09
566-15
25 X 90 mm

566-10
566-16
24X75 mm

566-11
566-17
22X65 mm

566-12
566-18
20X25 mm

Davis-Boyle, Left
566-08 To 566-12
Blades with suction device
566-13
Complete consisting :
1 Frame
5 Blades

Davis-Boyle, Right
566-14 To 566-18
Blades with suction device
566-19
Complete consisting :
1 Frame
5 Blades

ABRIDOR DE BOCA

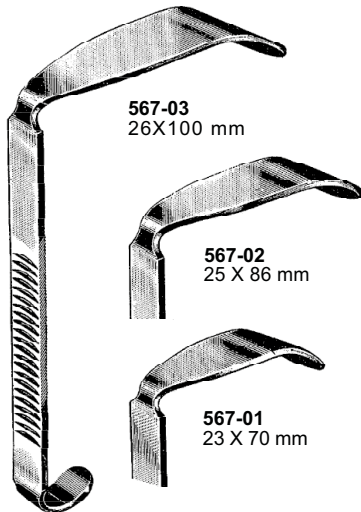

Mclvor
567-01 To 567-03
 Blades only
567-04
 Complete consisting :
 1 Frame 567-09
 3 Blades

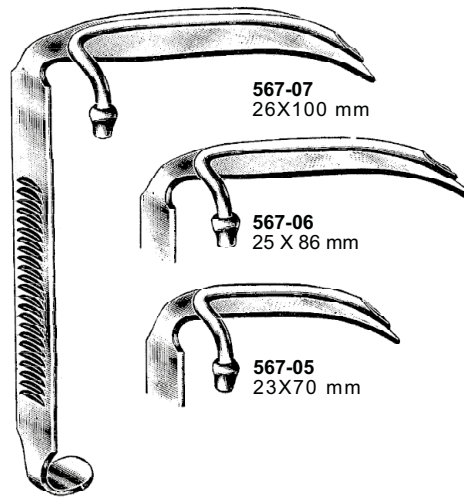

Mclvor
567-05 To 567-07
 Blades with suction device
567-08
 Complete consisting :
 1 Frame 567-09
 3 Blades

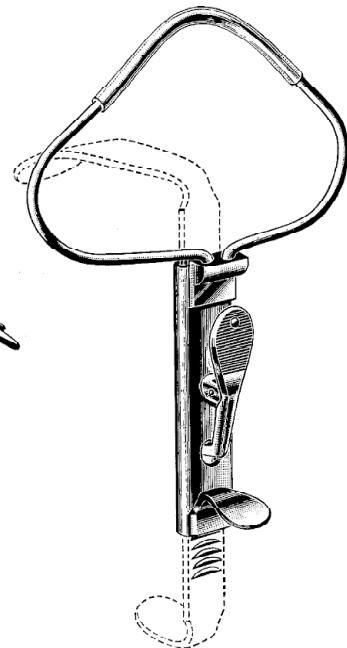

Mclvor
567-09
 Frame only

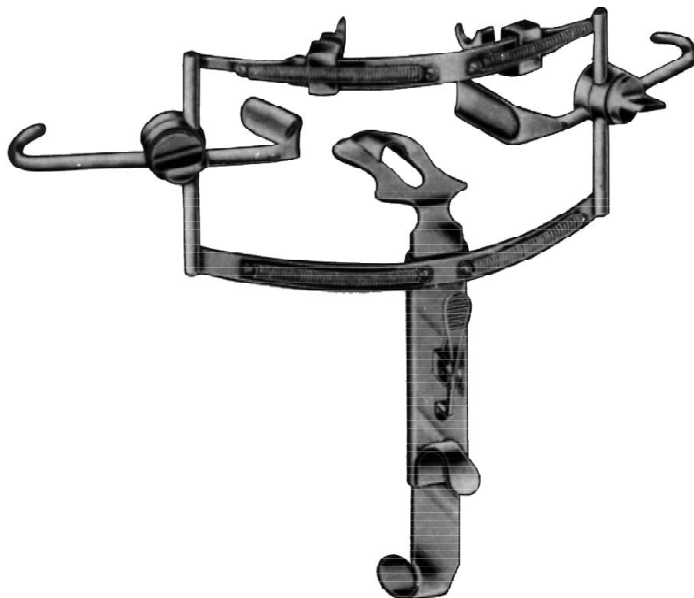

Dingman
567-10 To 567-12
 Blades only
567-13
 Complete consisting :
 1 Frame
 3 Blades
 2 Retractors



567-10



567-11



567-12

ABRIDOR DE BOCA E ABAIXADORES DE LÍNGUA

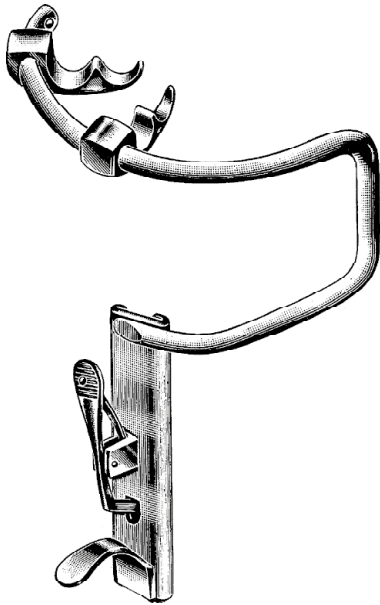

Negus
569-01 To 569-03
 Blades with suction device
569-04
 Complete consisting :
 1 Frame
 3 Blades
 2 Adjustable tooth plates

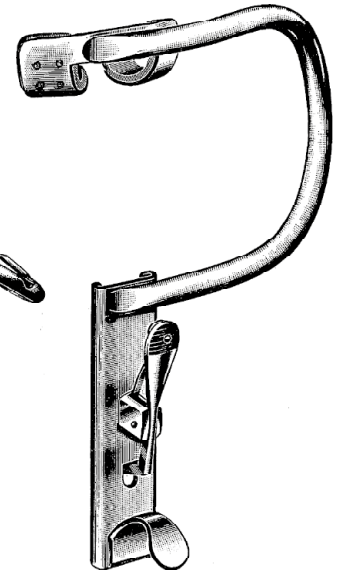
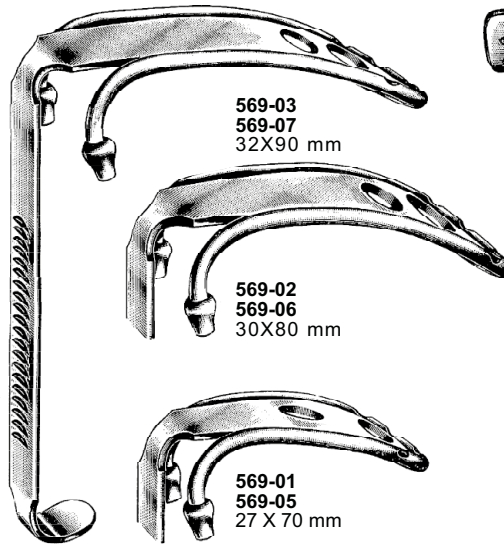

Negus
569-05 To 569-07
 Blades with suction device
569-08
 Complete consisting :
 1 Frame, Standard
 3 Blades



569-12
 14.5 cm / 5 3/4"

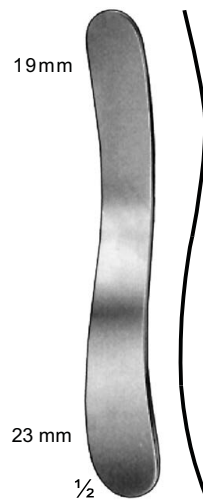

569-13
 14 cm / 5 1/2"

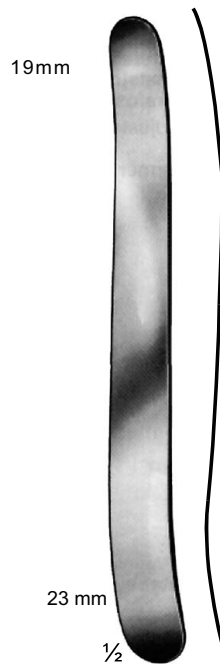

Buchwald
569-14
 18 cm / 7"

ABAIXADORES DE LÍNGUA



570-01
14.5 cm / 5¾"



Mayo
570-02
17 cm / 6¾"

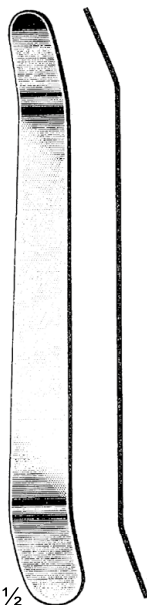

570-03
16.5 cm / 6½"

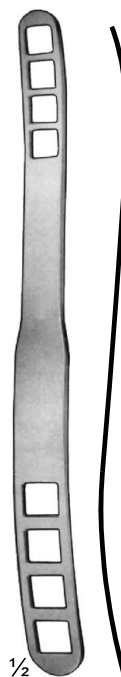

Bruenings
570-04
19 cm / 7½"

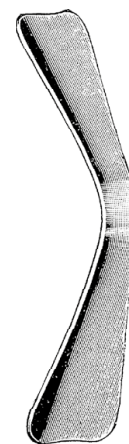

Doyen
570-05 13 cm / 5¼"
570-06 16 cm / 6¼"

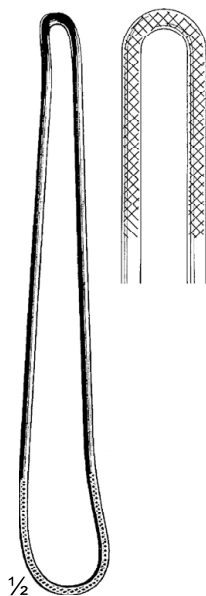

Frenzel
570-07
16.5 cm / 6½"

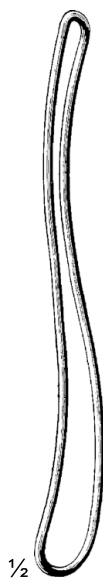

Collin
570-08
16.5 cm / 6½"

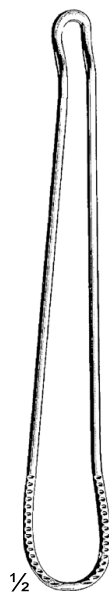

570-09
16.5 cm / 6½"



Tobold
570-10
12 cm / 4¾"

ABAIXADORES DE LÍNGUA

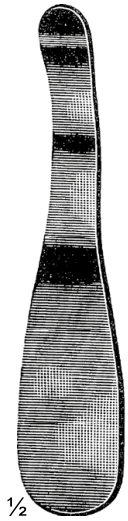

1/2
Baginski
571-01
15 cm / 6"

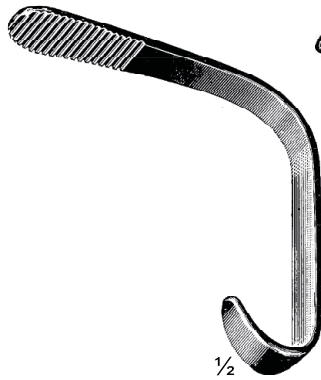

1/2
Andrew
571-02 11 cm / 4 1/4"
571-03 13 cm / 5 1/8"
571-04 15 cm / 6"

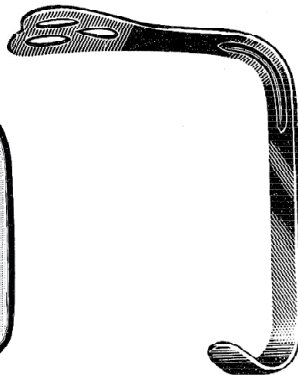

Weder
571-05 & 571-06

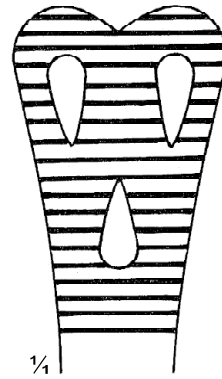

1/4
571-05
14 cm / 5 1/2"
28 mm

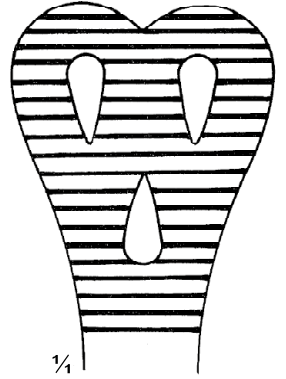

1/4
571-06
15 cm / 6"
32 mm

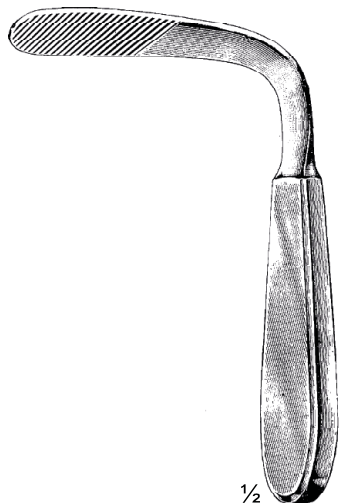

1/2
Tobold
571-08 14.5 cm / 5 3/4"
571-09 15 cm / 6"
571-10 16.5 cm / 6 1/2"

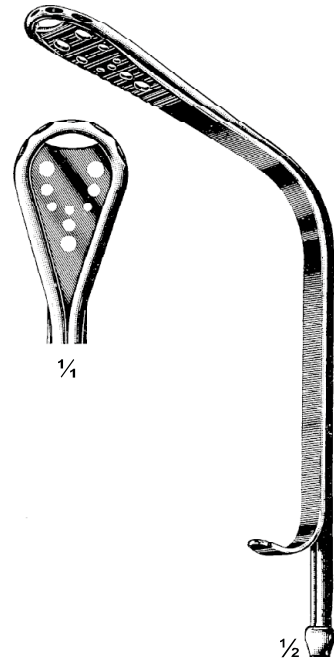

1/2
Le Mee
571-14
21 cm / 8 1/4"

ABAIXADORES DE LÍNGUA E AFASTADORES LABIAIS



University of Minnesota
572-02
14 cm / 5½"



1/2
Sternberg
572-07 12 cm / 4¾"
572-08 14 cm / 5½"
572-09 16 cm / 6¼"
572-10 18 cm / 7"

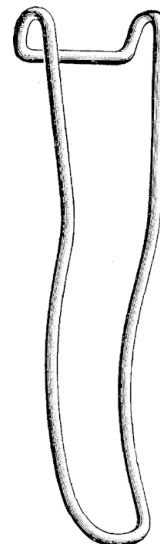

Sternberg
572-11 12 cm / 4¾"
572-12 14 cm / 5½"
572-13 16 cm / 6¼"
572-14 18 cm / 7"

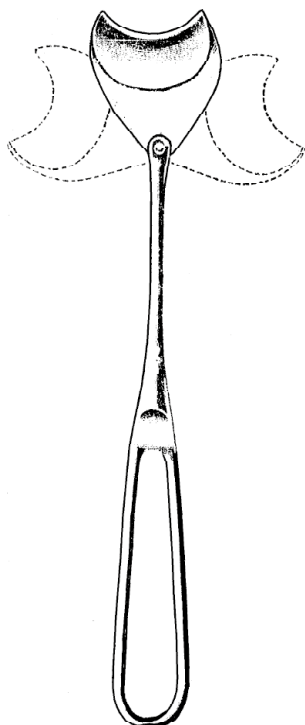

572-15
19 cm / 7½"

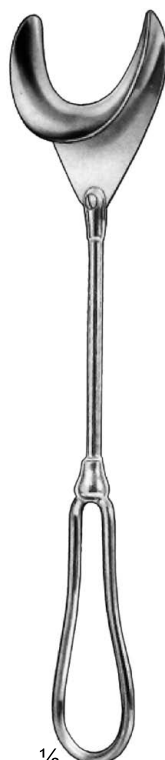

1/2
572-16
21 cm / 8¼"

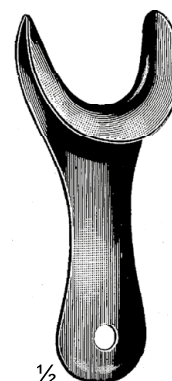

1/2
573-01
11 cm / 4¼"

AFASTADORES INTRAORAIS

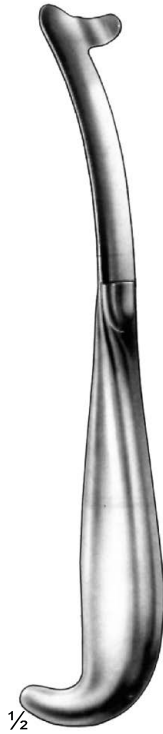
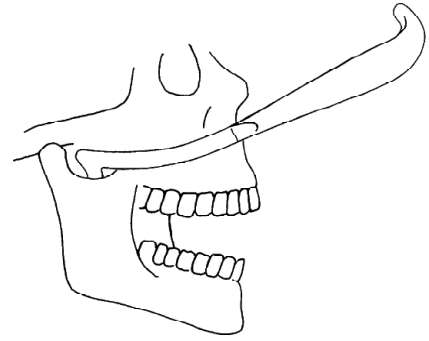
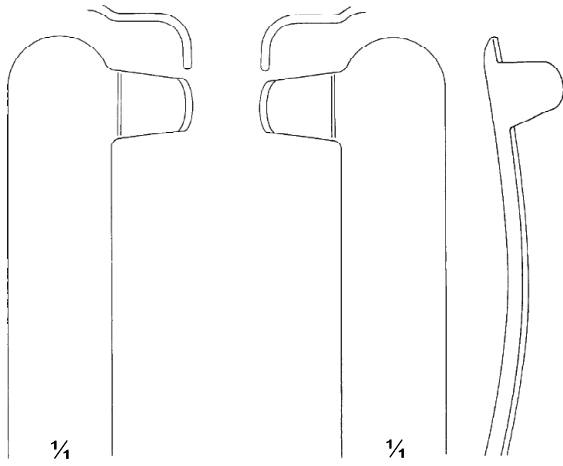

Bauer
574-01
21.5 cm / 8½"
Right



Bauer
574-02
21.5 cm / 8½"
Left

AFASTADORES INTRAORAIS

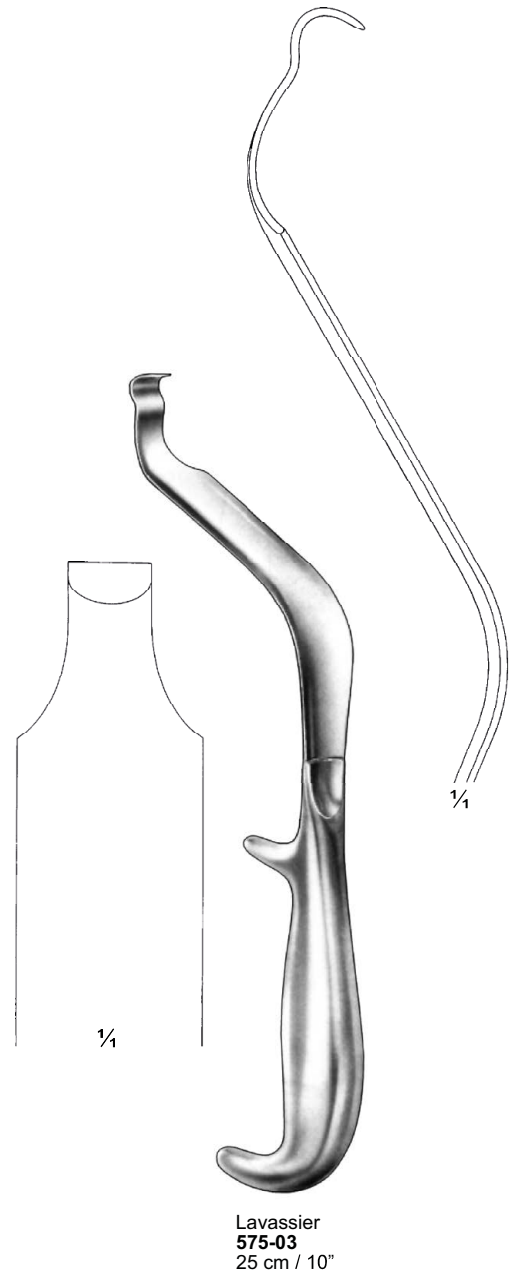
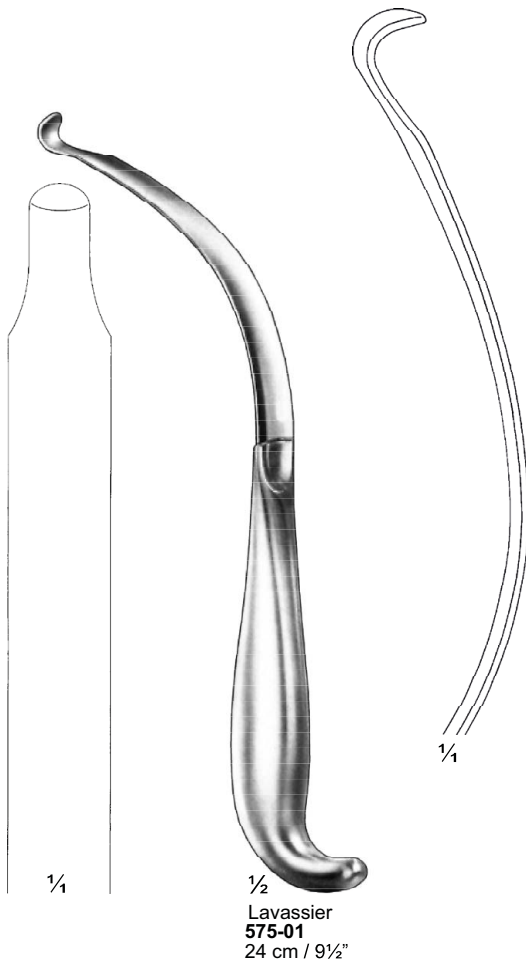
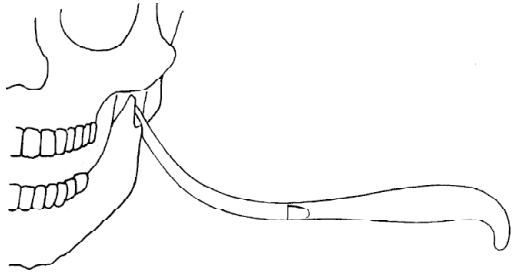

AFASTADORES PARA MANDÍBULA E QUEIXO

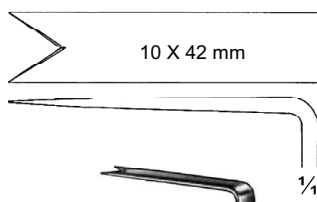

10 X 42 mm

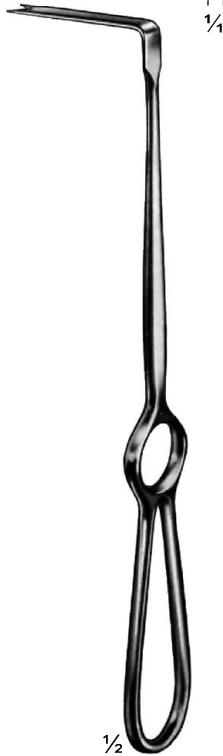
 $\frac{1}{2}$

Obwegeser
577-01
22 cm / 8 $\frac{3}{4}$ "

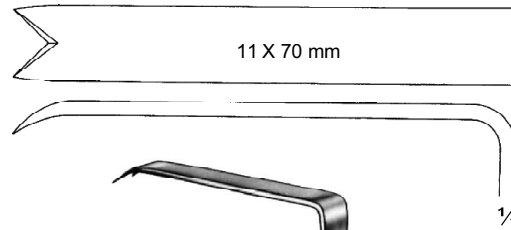

11 X 70 mm

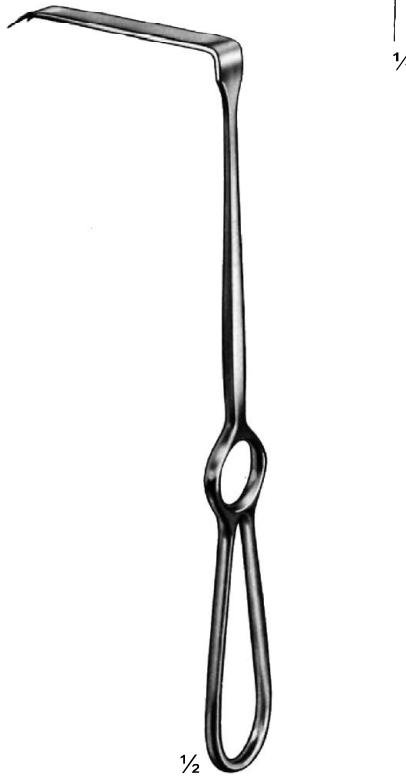
 $\frac{1}{2}$

Obwegeser
577-02
22 cm / 8 $\frac{3}{4}$ "

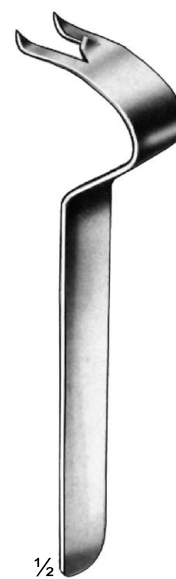
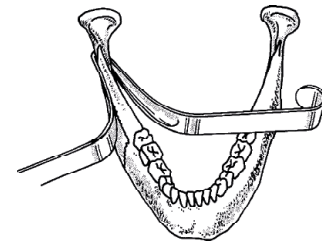
 $\frac{1}{2}$

Obwegeser
577-03
16.5 cm / 6 $\frac{1}{2}$ "

 $\frac{1}{2}$

Obwegeser
577-04 8 mm
577-05 10mm
16.5 cm / 6 $\frac{1}{2}$ "

CABOS PARA ESPELHO

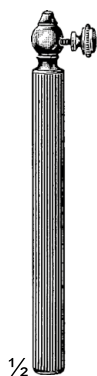

$\frac{1}{2}$
580-53
7 cm / 2 $\frac{3}{4}$ "



$\frac{1}{2}$
580-54
11 cm / 4 $\frac{1}{4}$ "



$\frac{1}{2}$
581-01
11 cm / 4 $\frac{1}{4}$ "



$\frac{1}{2}$
581-02
10.5 cm / 4 $\frac{1}{8}$ "



$\frac{1}{1}$
581-03
12 cm / 4 $\frac{3}{4}$ "



$\frac{1}{1}$
581-04
13 cm / 5 $\frac{1}{8}$ "



Tecnologia Alemã **Pius Lang:**



Distribuído por:



www.stetten.com.br

Rua Luiza Grinalda, 550, Ed. Plaza Top Center, sala 201, Centro, Vila Velha/ES. CEP 29100-240
27 3534-5752 • admfarbo@farbomedical.com.br