



stetten
INSTRUMENTAIS CIRÚRGICOS

CHAVES E EXTENSORES

TREPANO MANUAL E ALARGADORES



Hudson
540-01 To 540-08
 27 cm / 10½"
540-09
 With 8 drills and
 extension piece

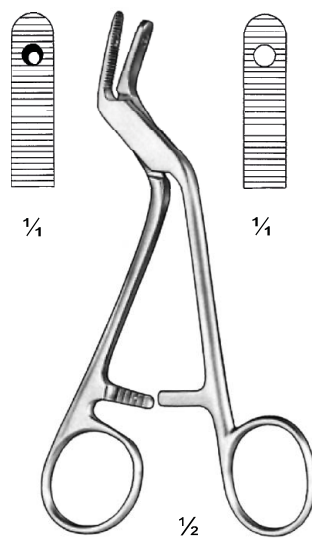

Adson
540-14
 15cm / 6"

CHAVES

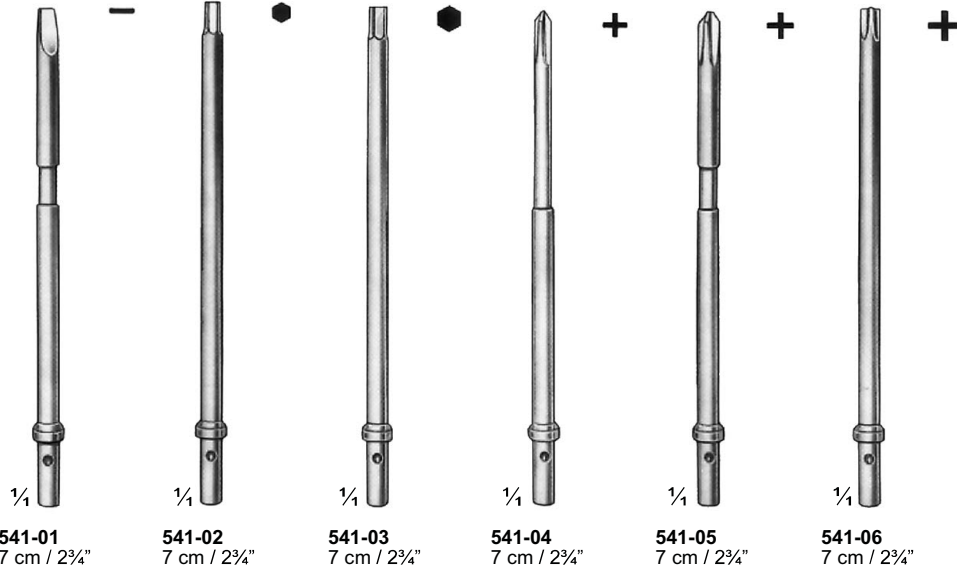

541-01
7 cm / 2¾"

541-02
7 cm / 2¾"

541-03
7 cm / 2¾"

541-04
7 cm / 2¾"

541-05
7 cm / 2¾"

541-06
7 cm / 2¾"



541-07
16 cm / 6¼"
Handle only with rapid chuck

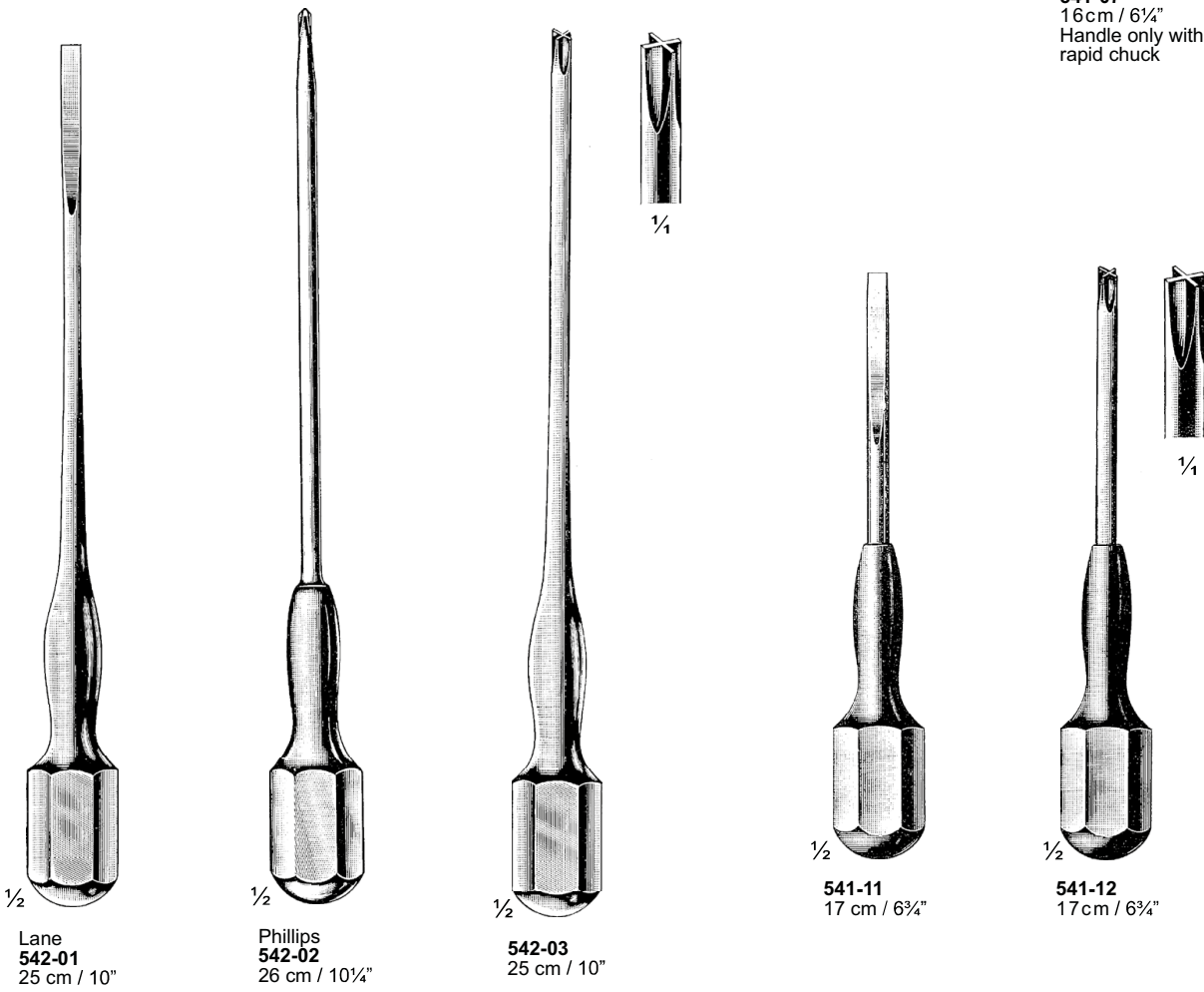

Lane
542-01
25 cm / 10"

Phillips
542-02
26 cm / 10¼"

542-03
25 cm / 10"

541-11
17 cm / 6¾"

541-12
17 cm / 6¾"

CHAVES

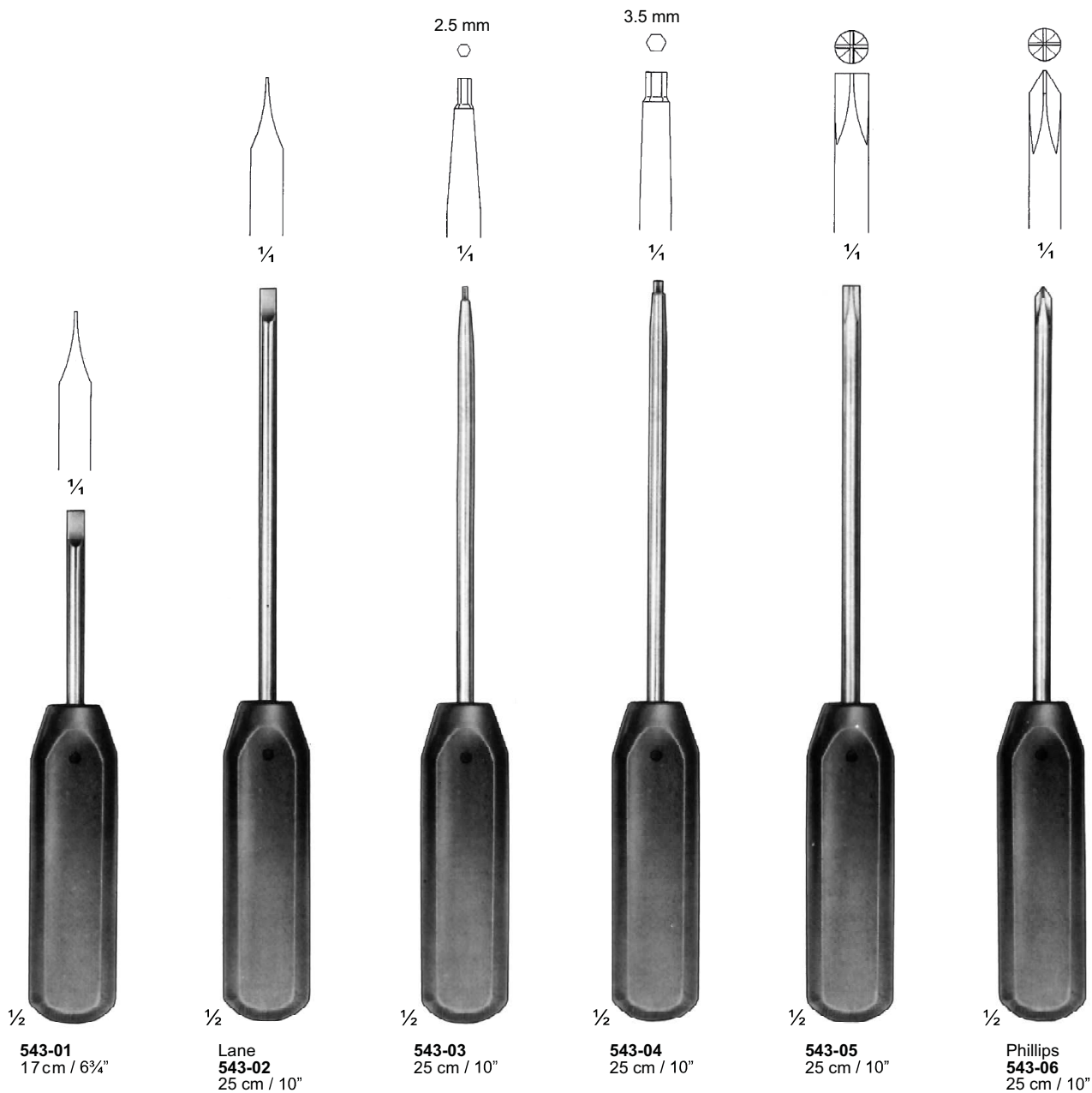

PINOS DE FRATURAS E ARCOS DE EXTENSÃO



Kirschner
545-16
 6 X 6 cm / 2½ X 2½"
 With 3 traction hooks

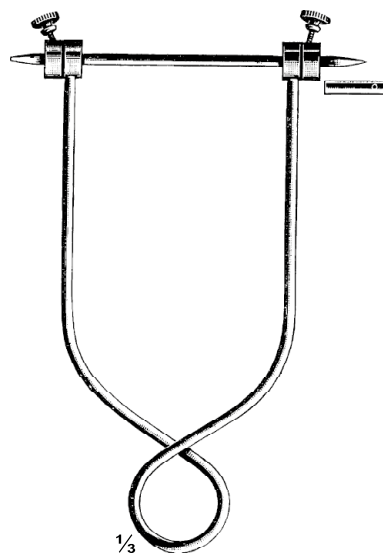

Bohler
545-17 16 X 9 cm / 6¼ X 3½"
 For arm, With 1 pin
545-18 21 X 11 cm / 8¼ X 4½"
 For thigh and knee, With 1 pin
545-19 21 X 15 cm / 8¼ X 6"
 For femur and knee, With 1 pin

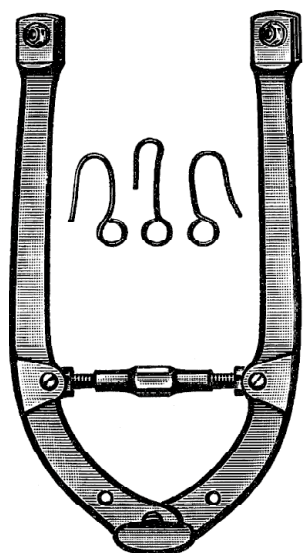

Kirschner
545-21 4-14 X 11.5 cm / 1½-5½ X 4½"
545-22 6.5-15 X 11 cm / 2½-6 X 4¼"
545-23 6-22 X 18 cm / 2¼-8¾ X 7"
 With 3 traction hooks

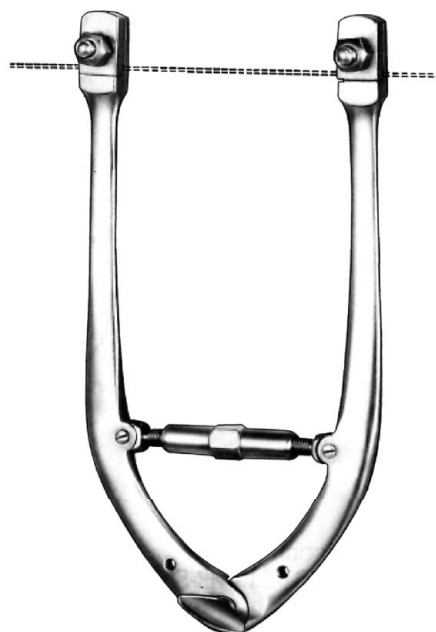

545-24
 18 X 10 cm / 7 X 4"
545-25
 27 X 27 cm / 10½ X 10½"

ARCOS DE EXTENSÃO E PINOS DE ARAME

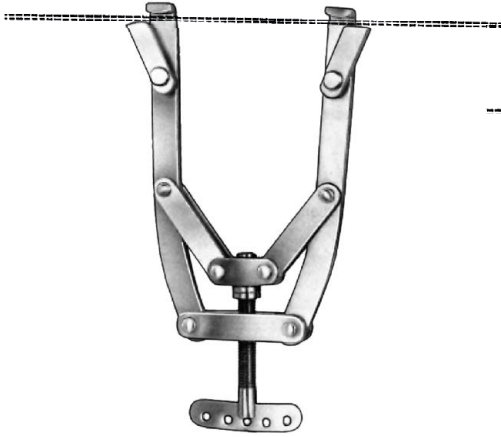

Kirschner
546-01
 0-40 mm X 18.5 cm / 7¼"
546-02
 35-200 mm X 27 cm / 10½"
 With 3 traction pins

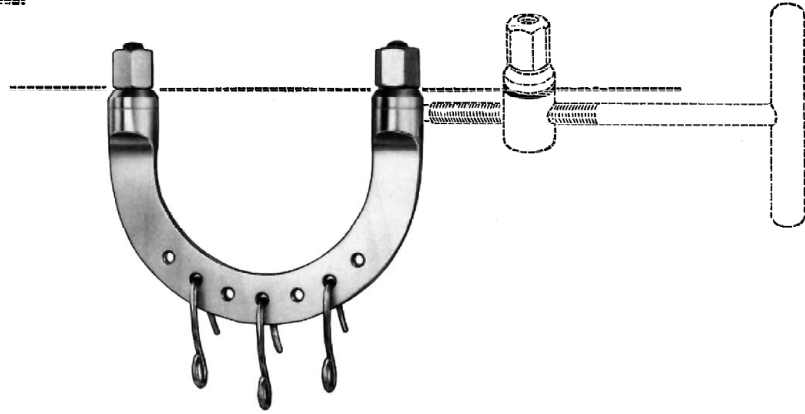

Kirschner
546-03 9.5 X 7 cm / 3¾ X 2¾"
546-04 10.5 X 10.5 cm / 4¼ X 4¼"
546-05 12 X 12 cm / 4¾ X 4¾"
546-06 15 X 15 cm / 6 X 6"
546-07 20 X 15 cm / 8 X 6"
 With 3 traction pins

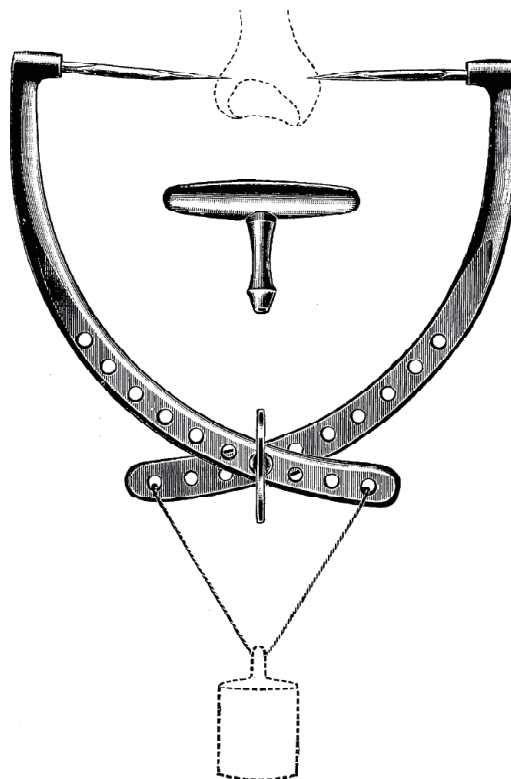

Steinmann
546-08
 Complete consisting :
 1 Key, 2 Pins 8mm, 2 Pins 10 mm,
 2 Pins 12 mm, 2 Pins 14mm,
 2 Pins 16 mm, 2 Pins 20 mm

EXTENSÕES DE FIOS E GUIA DE FIOS DE OSSOS



Demel
547-01 To 547-03

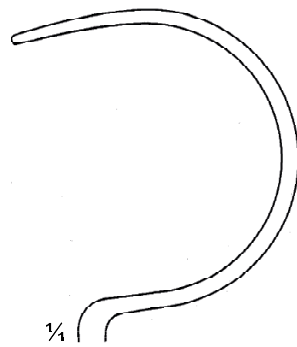

547-01
27.5 cm / 10¾"

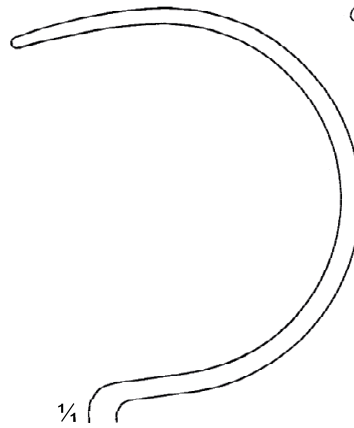

547-02
28.5 cm / 11¼"

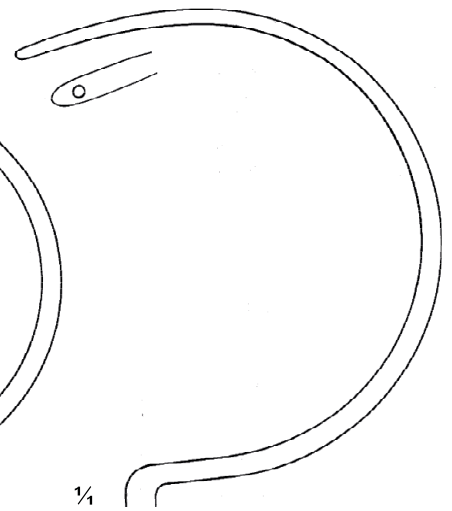

547-03
30 cm / 12"

GUIA DE FIOS DE OSSOS E APERTADORES

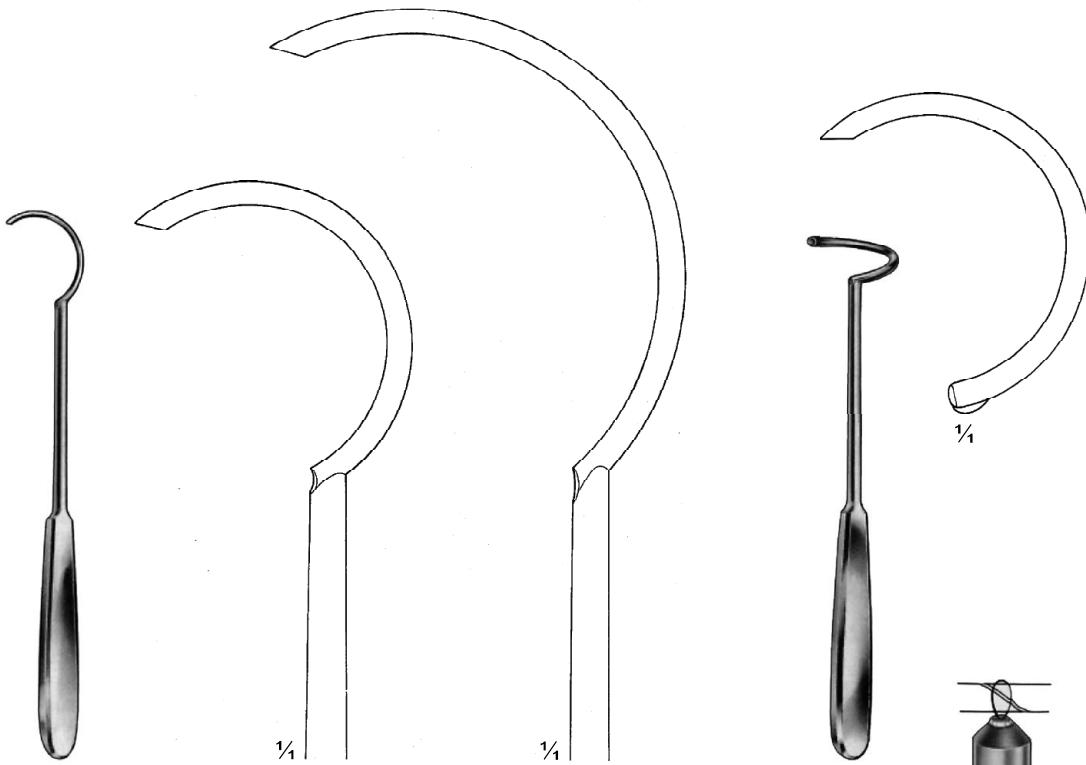

548-01 & 548-02

548-01
24 cm / 9½"

548-02
27 cm / 10½"

548-03
23 cm / 9"

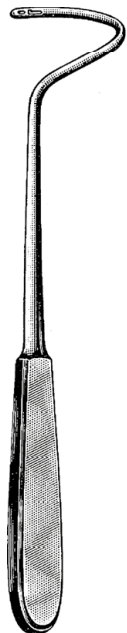

Parham
548-04
23 cm / 9"

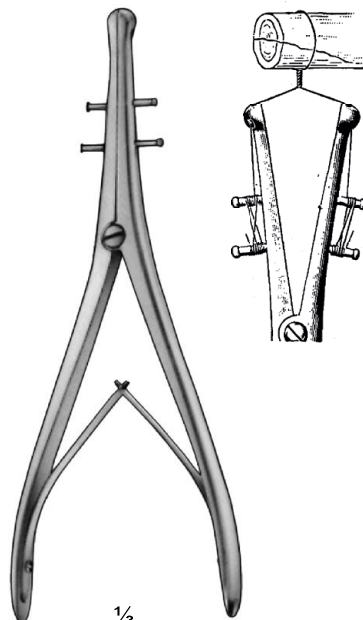

Demel
548-10
27 cm / 10½"

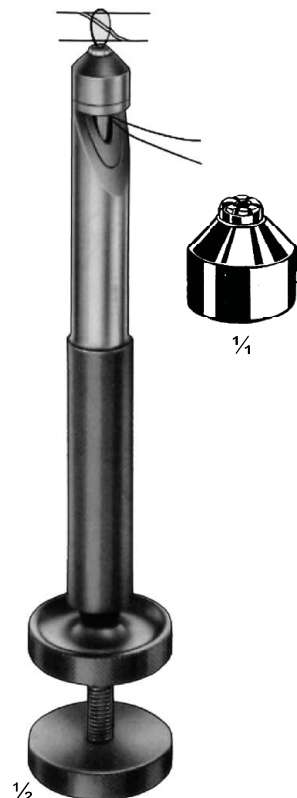

Loute
548-11
22 cm / 8¾"



Tecnologia Alemã **Pius Lang:**



Distribuído por:



www.stetten.com.br

Rua Luiza Grinalda, 550, Ed. Plaza Top Center, sala 201, Centro, Vila Velha/ES. CEP 29100-240
27 3534-5752 • admfarbo@farbomedical.com.br