



stetten
INSTRUMENTAIS CIRÚRGICOS

CURETAS

CURETAS PARA OSSOS

Bruns
478-01 To 478-10
17 cm / 6 3/4"

Spratt
478-11 To 478-19
17 cm / 6 3/4"

Halle
478-20 To 478-22
21 cm / 8 1/4"

Halle
478-23 To 478-25
21.5 cm / 8 1/2"

Daubenspeck
479-27 To 479-30
20 cm / 8"

Volkmann
479-41 To 479-50
17 cm / 6 3/4"

Halle
479-31 To 479-50
21 cm / 8 1/4"

CURETAS PARA OSSOS

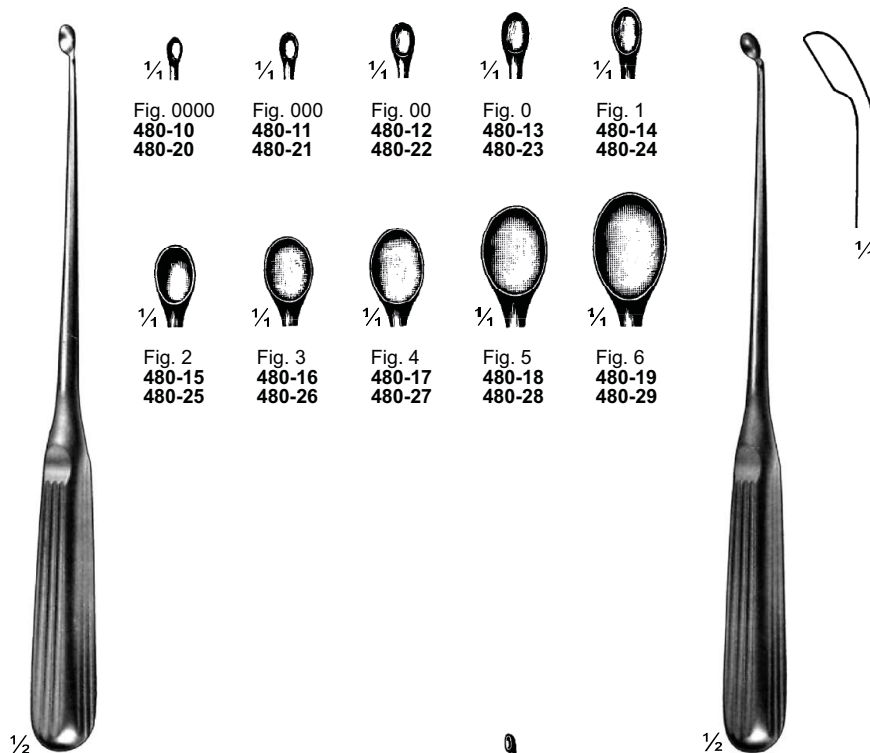

Bruns (Volkmann)
480-10 To 480-19
21 cm / 8 1/4"

Bruns (Volkmann)
480-20 To 480-29
21 cm / 8 1/4"

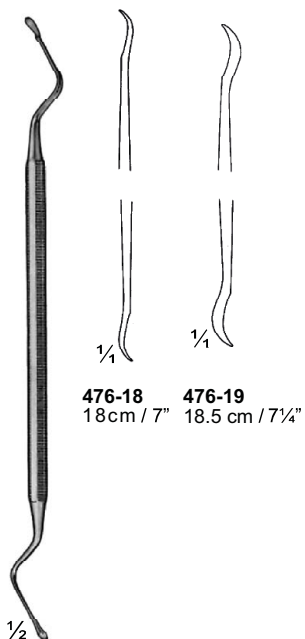

476-18 476-19
18 cm / 7" 18.5 cm / 7 1/4"

Lucas
476-18 & 476-19

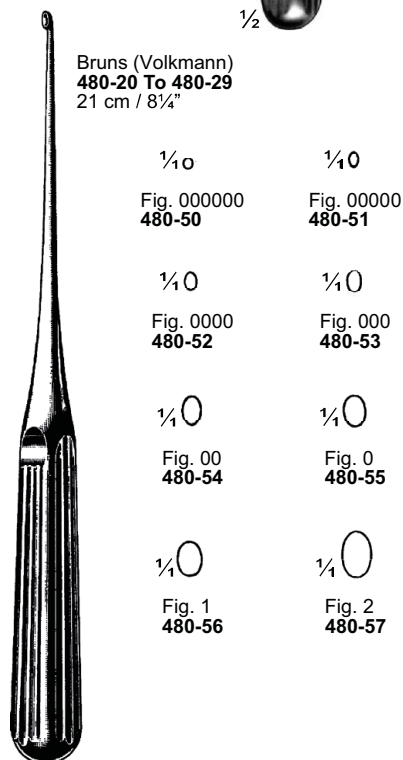

Lempert
480-50 To 480-57
20 cm / 8"

CURETAS PARA OSSOS

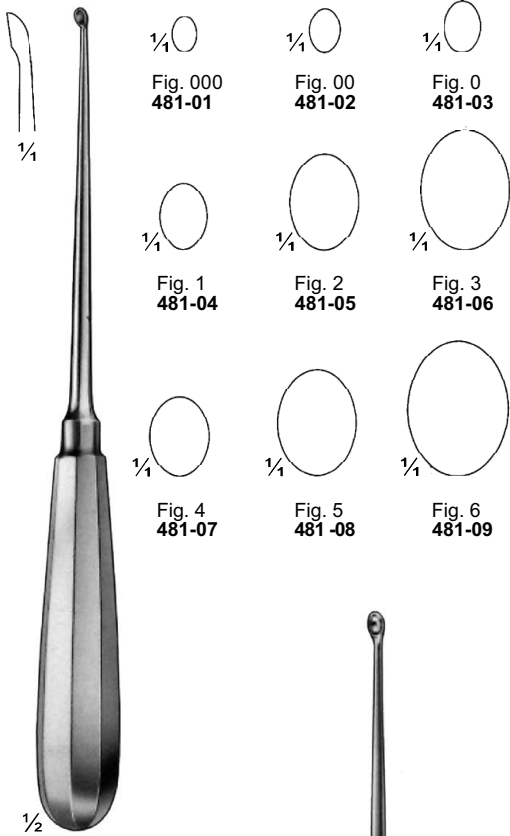

Simon
481-01 To 481-09
23.5 cm / 9 1/4"

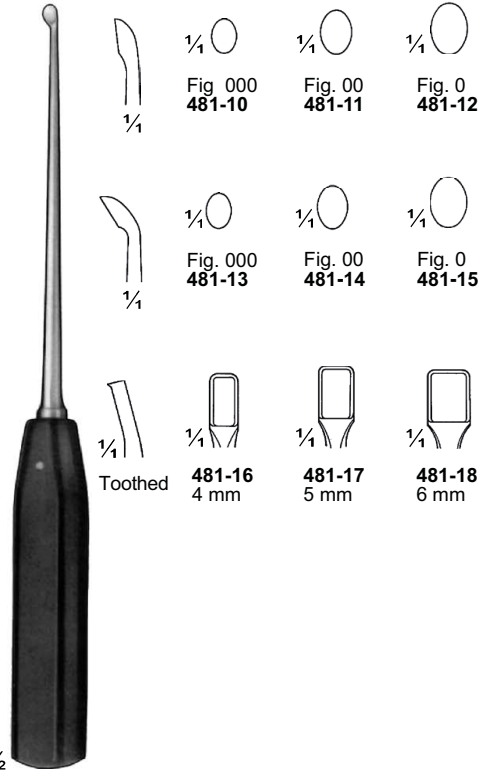

Caspar
481-10 To 481-18
22 cm / 8 3/4"



Volkman
481-21 To 481-32
25 cm / 10"

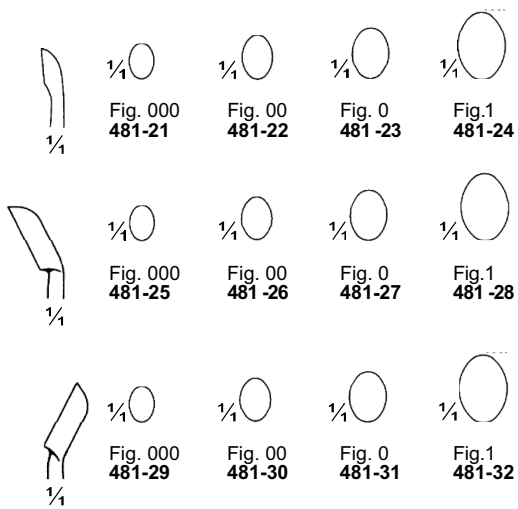

CURETAS PARA OSSOS

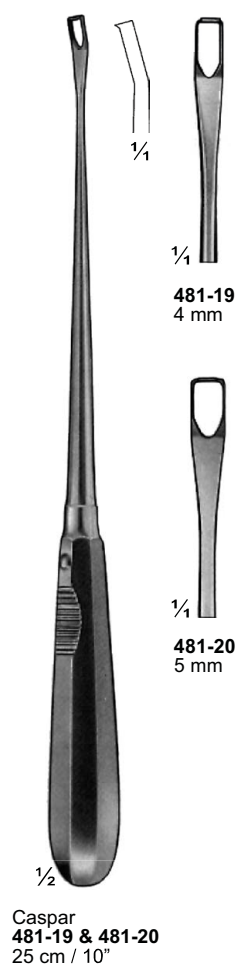

CURETAS PARA RINOPLASTIA



648-07

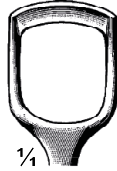

648-08



648-09

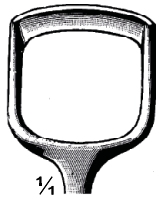

648-10

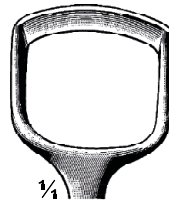

648-11

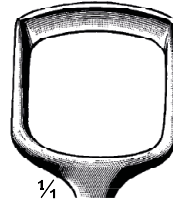

648-12



Beckmann
648-07 To 648-12
22 cm / 8 3/4"



Coakley
647-06 To 647-08
17 cm / 6 3/4"



647-06
647-12



647-07
647-13



647-08
647-14



Coakley
647-12 To 647-14
19cm / 7 1/2"



Faulkner
647-18
21 cm / 8 1/4"



Pratt
647-19
21 cm / 8 1/4"



Dingman
647-04
15 cm / 6"
Left



Dingman
647-05
15 cm / 6"
Right

CURETAS AURICULARES

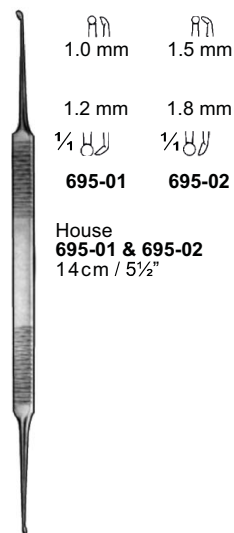

House
695-01 & 695-02
 14 cm / 5 1/2"

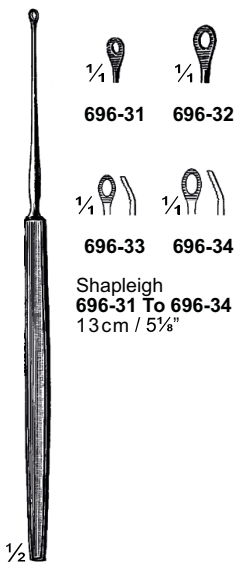

Shapleigh
696-31 To 696-34
 13 cm / 5 1/8"

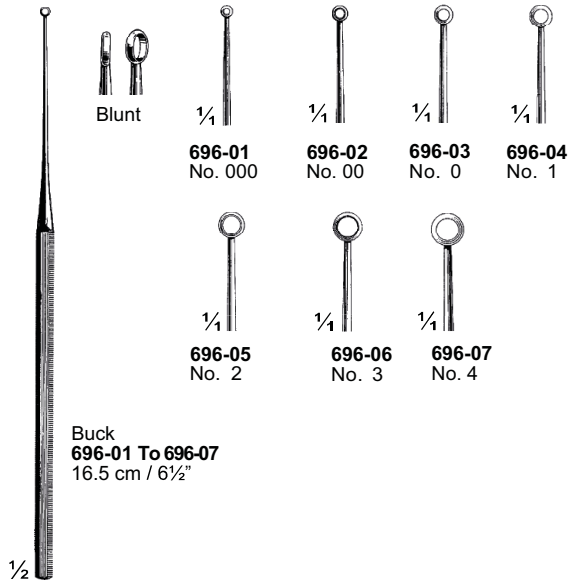

Buck
696-01 To 696-07
 16.5 cm / 6 1/2"

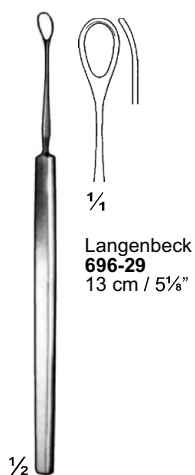

Langenbeck
696-29
 13 cm / 5 1/8"

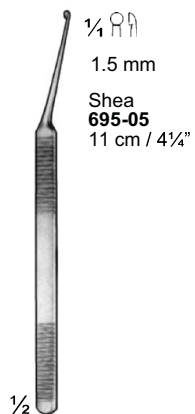

Shea
695-05
 11 cm / 4 1/4"



Gross
697-13
 12 cm / 4 3/4"
 Blunt

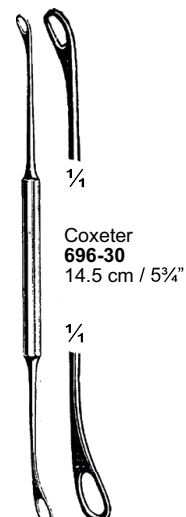

Coxeter
696-30
 14.5 cm / 5 3/4"

CURETAS OFTALMOLÓGICAS E NEUROCIRÚRGICAS



Meyhoefer
717-01 To 717-08

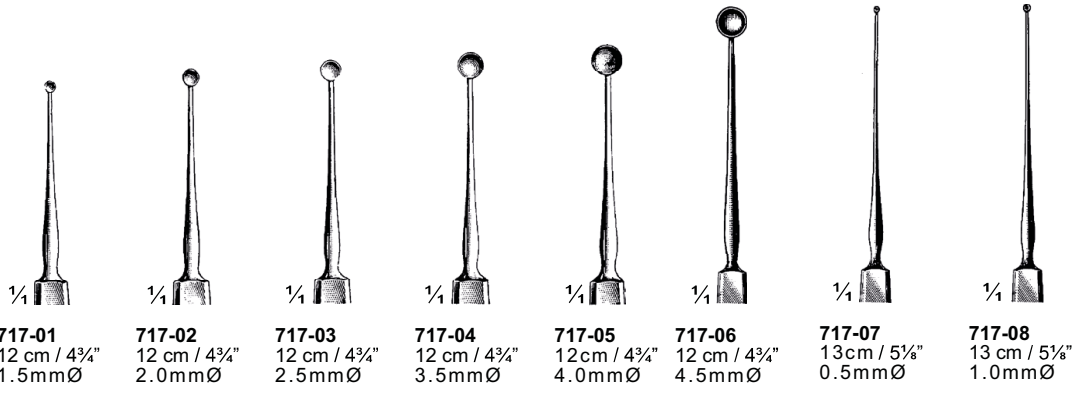

- 717-01**
12 cm / 4 3/4"
1.5mmØ
- 717-02**
12 cm / 4 3/4"
2.0mmØ
- 717-03**
12 cm / 4 3/4"
2.5mmØ
- 717-04**
12 cm / 4 3/4"
3.5mmØ
- 717-05**
12 cm / 4 3/4"
4.0mmØ
- 717-06**
12 cm / 4 3/4"
4.5mmØ
- 717-07**
13 cm / 5 1/8"
0.5mmØ
- 717-08**
13 cm / 5 1/8"
1.0mmØ



Scoville
761-01 To 761-03
25 cm / 10"

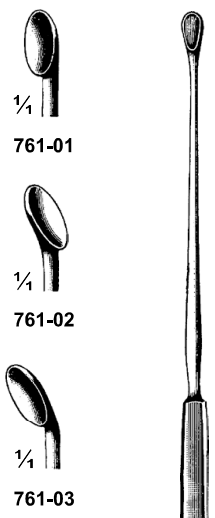

- 761-01**
- 761-02**
- 761-03**



Cushing
761-10 To 761-14
23.5 cm / 9 1/4"

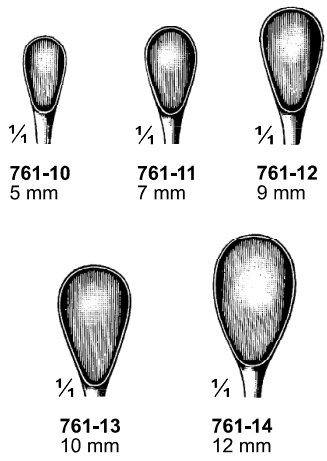

- 761-10**
5 mm
- 761-11**
7 mm
- 761-12**
9 mm
- 761-13**
10 mm
- 761-14**
12 mm

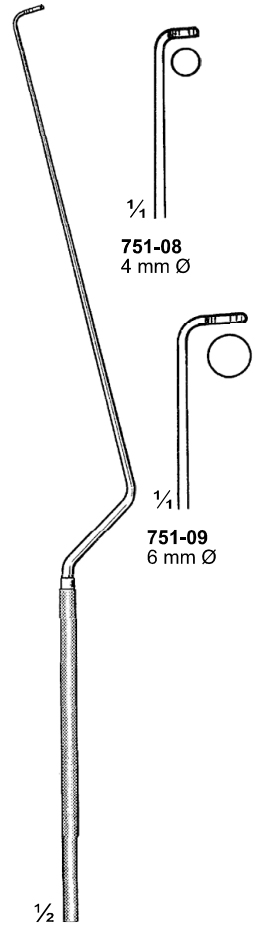

Hardy
751-08 & 751-09
26 cm / 10 1/4"

- 751-08**
4 mm Ø
- 751-09**
6 mm Ø

CURETAS NEUROCIRÚRGICAS

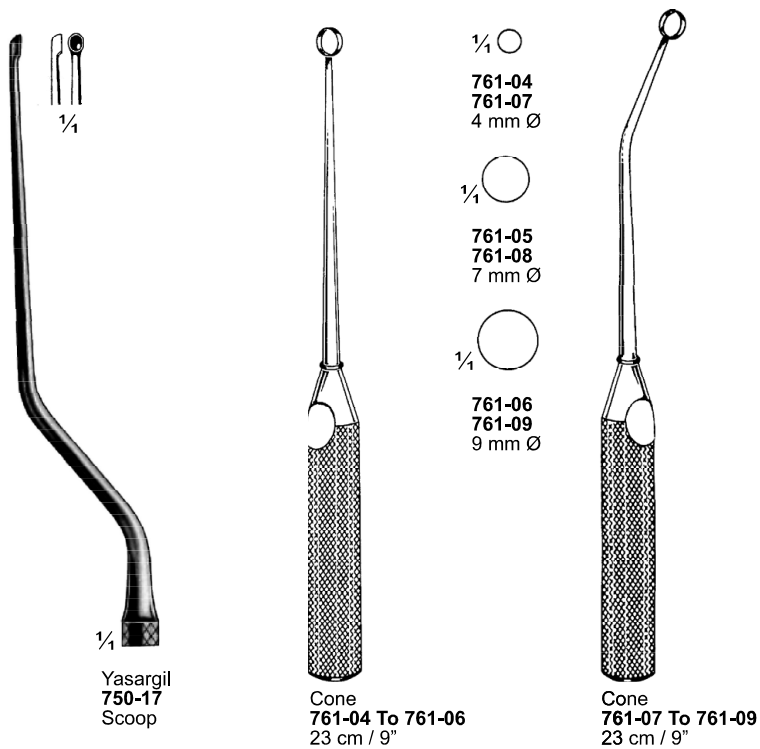
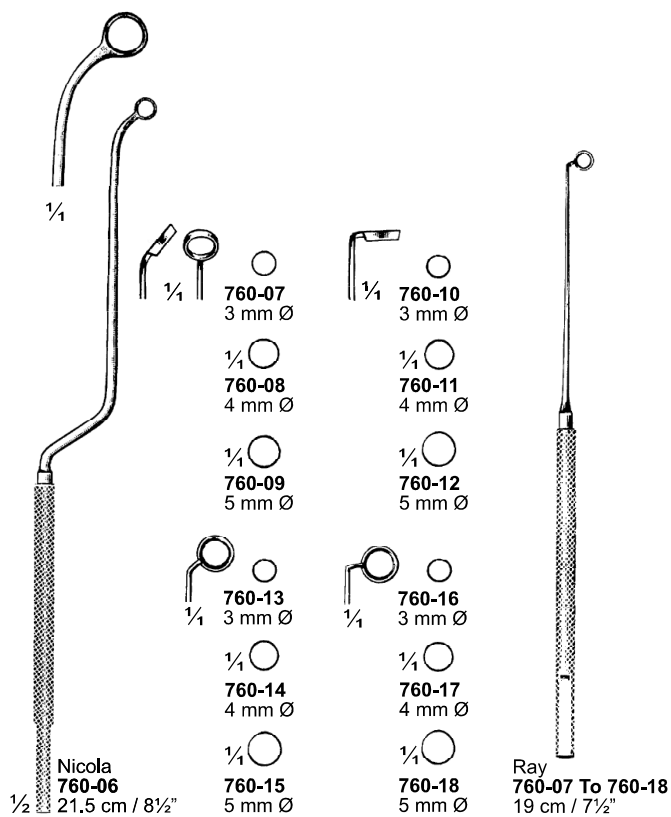

CURETAS

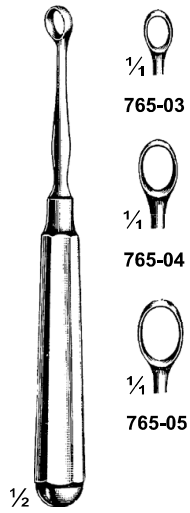

Piffard
765-03 To 765-05
14.5 cm / 5 3/4"

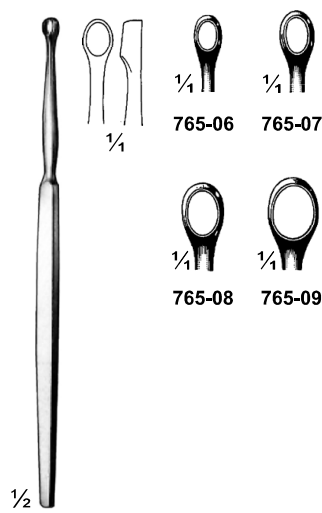

Fox
765-06 To 765-09
14.5 cm / 5 3/4"

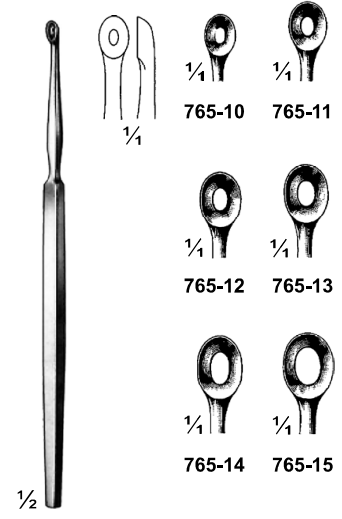

Wolff
765-10 To 765-15
14.5 cm / 5 3/4"

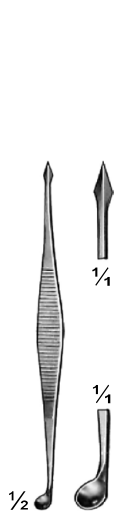

Saalfeld
766-04
10 cm / 4"



Saalfeld
766-05
10.5 cm / 4 1/8"

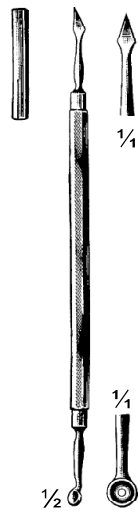

Katsch
765-21
14 cm / 5 1/2"

CURETAS PARA REMOÇÃO E BIÓPSIA UTERINA



Mayo
860-07
28 cm / 11"



Fergusson
860-08 To 860-10



860-08
21.5 cm / 8½"



860-09
22 cm / 8¾"



860-10
23.5 cm / 9¼"



Mayo
862-03 To 862-05
26 cm / 10¼"
Malleable



862-03
4 mm



862-04
5 mm



862-05
7 mm

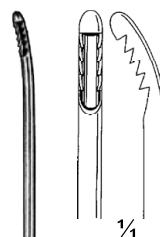

Novak
907-03
23 cm / 9"
½" Ø 4 mm

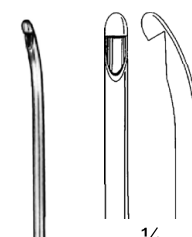

Randall
907-05
24 cm / 9½"
½" Ø 4 mm

CURETAS UTERINAS

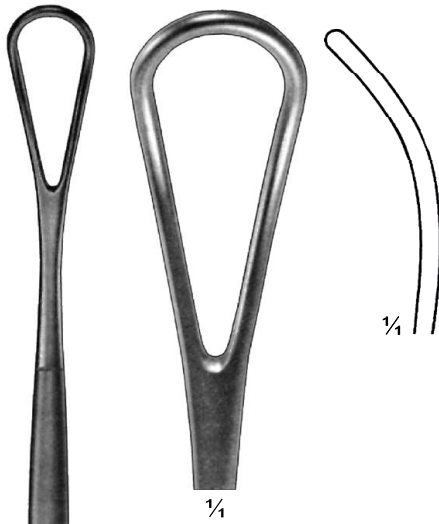

Braun
902-01
27 cm / 10½"

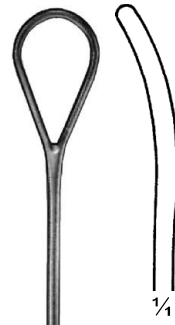

902-02
28.5 cm / 11¼"
15mm



902-03
26 cm / 10¼"
25mm

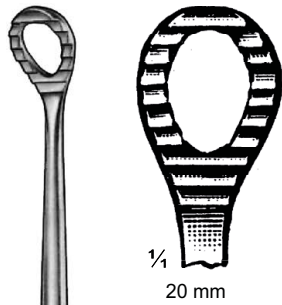

20 mm

Braun
902-02 To 902-04



902-04
27 cm / 10½"
35 mm

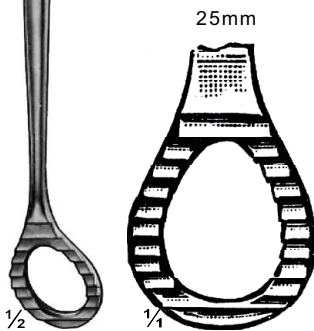

25mm

Sims
902-05
26 cm / 10¼"

CURETAS UTERINAS



$\frac{1}{2}$
Racamier
909-03 To 909-08 Sharp
 31 cm / 12 $\frac{1}{2}$ "

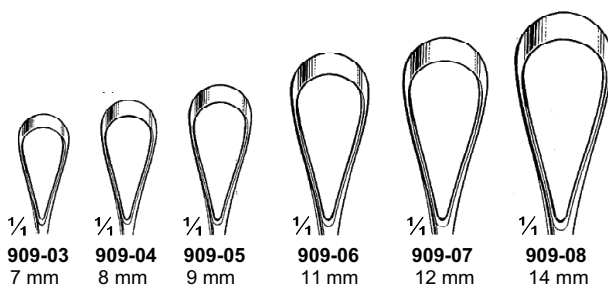

$\frac{1}{4}$ **909-03** 7 mm $\frac{1}{4}$ **909-04** 8 mm $\frac{1}{4}$ **909-05** 9 mm $\frac{1}{4}$ **909-06** 11 mm $\frac{1}{4}$ **909-07** 12 mm $\frac{1}{4}$ **909-08** 14 mm

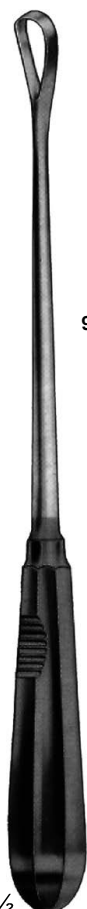

$\frac{1}{2}$
Sims
911-13 To 911-18 Sharp
 26 cm / 10 $\frac{1}{4}$ "

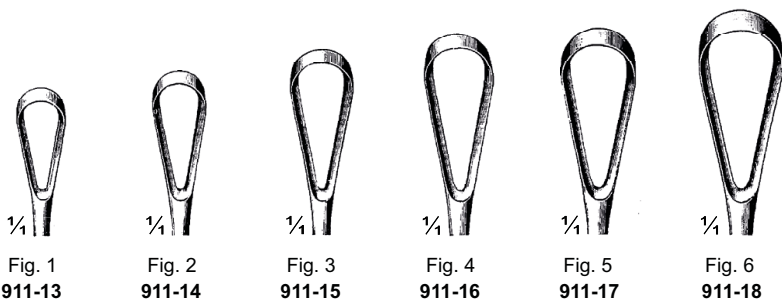

$\frac{1}{4}$ **Fig. 1** **911-13** $\frac{1}{4}$ **Fig. 2** **911-14** $\frac{1}{4}$ **Fig. 3** **911-15** $\frac{1}{4}$ **Fig. 4** **911-16** $\frac{1}{4}$ **Fig. 5** **911-17** $\frac{1}{4}$ **Fig. 6** **911-18**

CURETAS UTERINAS



Schroeder
919-01 To 919-06
30 cm / 12"
Sharp



Fig. 1
919-01
7 mm



Fig. 2
919-02
8 mm



Fig. 3
919-03
10 mm



Fig. 4
919-04
11 mm



Fig. 5
919-05
12mm

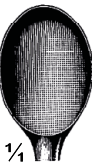

Fig. 6
919-06
15mm



Simon
918-01 To 918-06
25 cm / 10"
Sharp



Fig. 1
918-01
7 mm



Fig. 2
918-02
8 mm



Fig. 3
918-03
10 mm



Fig. 4
918-04
11 mm



Fig. 5
918-05
12mm



Fig. 6
918-06
15mm

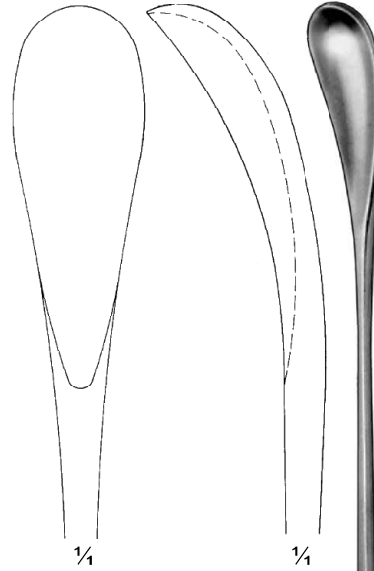

Wallich
913-10
42 cm / 16 3/4"



Tecnologia Alemã **Pius Lang:**



Distribuído por:



www.stetten.com.br

Rua Luiza Grinalda, 550, Ed. Plaza Top Center, sala 201, Centro, Vila Velha/ES. CEP 29100-240
27 3534-5752 • admfarbo@farbomedical.com.br